

RS232/RS485 Communication Module CM-232/CM-485/CM-485T

Frequency Inverter 230V / 400V

ACTIVE and ACTIVE Cube



General Information about the Documentation

The present supplement of the operating instructions is valid for frequency inverters of the device series ACT and ACU. The information necessary for the assembly and application of the communication modules CM-232 and CM-485 is documented in this guidance.

For better clarity, the user documentation is structured according to the customer-specific demands made on the frequency inverter.

Brief instructions

The brief instructions manual "Quick Start Guide" describes the fundamental steps for mechanical and electrical installation of the frequency inverter. The guided commissioning supports you in the selection of necessary parameters and the software configuration of the frequency inverter.

Operating instructions

The operating instructions document the complete functionality of the frequency inverter. The parameters necessary for specific applications for adaptation to the application and the extensive additional functions are described in detail.

Application manual

The application manual supplements the documentation for purposeful installation and commissioning of the frequency inverter. Information on various subjects connected with the use of the frequency inverter are described specific to the application.

Installation instructions

As a complement to the brief instructions and the operating instructions, the installation instructions describe the installation and use of devices.

The documentation and additional information can be requested via your local representation of the firm of BONFIGLIOLI.

The following pictograms and signal words are used for the purposes of the present documentation:



Danger!

Danger refers to an immediate threat. Non-compliance with the precaution described will result in death, serious injury or material damage.



Warning!

Warning refers to a possible threat. Non-compliance with the warning may result in death, serious injury or material damage.



Caution!

Caution refers to an immediate hazard. Non-compliance may result in personal or material damage.

Attention!

Attention and the related text refer to a possible behavior or an undesired condition which can occur during operation.

Note

marks information that facilitates handling for you and supplements the corresponding part of the documentation.



Warning! In installation and commissioning, comply with the information in the documentation. You as a qualified person must read the documentation carefully before the start of the activity and obey the safety instructions. For the purposes of the instructions, "qualified person" designates a person acquainted with the installation, assembly, commissioning and operation of the frequency inverters and possessing the qualification corresponding to the activity.

TABLE OF CONTENTS

1	General safety and application information	5
1.1	General information.....	5
1.2	Proper use.....	5
1.3	Transport and storage	6
1.4	Handling and installation.....	6
1.5	Electrical connection.....	6
1.6	Operating information	7
1.7	Maintenance and serving.....	7
2	Introduction.....	8
3	Installation/Disassembly of the communication module.....	9
3.1	Installation	9
3.2	Disassembly.....	10
4	Socket connection/bus termination/line.....	11
4.1	RS232 module CM-232	11
4.2	RS485 module.....	12
4.2.1	RS485 module CM-485 DB9.....	12
4.2.2	RS485 module CM-485 T.....	12
4.2.3	Bus termination	13
5	Startup	14
5.1	General Information on Configuration	14
5.2	RS232 Module CM-232	16
5.2.1	Setting the Baud Rate	16
5.2.2	Setting the Address.....	16
5.3	RS485 Module CM-485	17
5.3.1	Setting the Baud Rate	17
5.3.2	Setting the Node Address	17
6	Protocol	18
6.1	Character Format.....	18
6.2	Telegram Types.....	19
6.2.1	Symbols/Data Types Used.....	19
6.2.2	Data types	20
6.2.3	Send Request / Enquiry Telegram	21
6.2.4	Setting Request / Select Telegram.....	22
6.3	Telegram frame	23
6.3.1	Representation of Address.....	23
6.3.2	Control Characters.....	23
6.3.3	The system bus Node-ID.....	24
6.3.4	Dataset.....	25
6.3.5	Parameter number.....	25
6.3.6	Data bytes	25
6.3.7	Control char ETX	25
6.3.8	Binary Checksum (BCC).....	26
6.4	Telegram Check/Error Acknowledgement	27
6.5	Monitoring Function (Timing/Watchdog)	28

6.6	Block access.....	29
7	Handling of Data Sets/Cyclic Writing	31
8	Example Telegrams.....	33
8.1	Data Type uInt (value range 0 ... 65535).....	33
8.2	Data Type Int (value range -32768 ... +32767).....	34
8.3	Data Type Long (value range -2^{31} ... $+2^{31}-1$)	35
8.4	Data Type String (max. 99 characters)	36
9	ACT Inverter Control/Reference Value	37
9.1	Control	39
9.1.1	Control via Contacts.....	39
9.1.2	Control via Control Word of Statemachine.....	42
9.1.2.1	Behavior in Case of Quick Stop.....	47
9.1.2.2	Behavior in state-transition 5.....	48
9.1.3	Control via Remote Contacts.....	49
9.2	Reference Value.....	53
9.2.1	Reference Frequency	53
9.2.2	Reference Percentage	54
10	ACU Inverter Control/Reference Value.....	55
10.1	Control via contacts/remote contacts.....	57
10.2	Control via state machine.....	60
10.2.1	Behavior in quick stop	64
10.2.2	Behavior in transition 5	65
10.2.3	Reference value/actual value	66
11	Parameter List.....	68
11.1	Actual Value Menu (VAL)	68
11.2	Parameter Menu (PARA)	68
12	Annex	70
12.1	Warning Messages.....	70
12.2	Error Messages	71
12.3	ASCII Tabelle (0x00 – 0x7F)	73

1 General safety and application information

This documentation has been produced with the greatest of care and extensively and repeatedly checked. For reasons of clarity, not all the detailed information on all types of the product and also not every imaginable case of installation, operation or maintenance has been taken into account. If you require further information or if specific problems which are not dealt with extensively enough in the documentation exist, you can request the necessary information via the local representation of the company BONFIGLIOLI.

We would also point out that the contents of this documentation are not part of a previous or existing agreement, assurance or legal relationship and are not intended to amend the same. All obligations of the manufacturer result from the underlying purchase contract, which also contains the complete and solely valid warranty regulation. These contractual warranty provisions are neither extended nor limited by the production of this documentation.

The manufacturer reserves the right to correct or amend the contents and the product information as well as omissions without prior notification and assumes no kind of liability for damage, injuries or expenditure to be put down to the aforementioned reasons.

1.1 General information



Warning! BONFIGLIOLI VECTRON frequency inverters have high voltage levels during operation, depending on their protection class, drive moving parts and have hot surfaces.

In the event of inadmissible removal of the necessary covers, improper use, wrong installation or operation, there is the risk of serious damage to persons or property.

To avoid any damage, only qualified staff may carry out the transport, installation, setup or maintenance work required. Comply with the s EN 50178, IEC 60364 (Cenelec HD 384 or DIN VDE 0100), IEC 60664-1 (Cenelec HD 625 or VDE 0110-1), BGV A2 (VBG 4) and national provisions. Qualified persons within the meaning of this principal safety information are people acquainted with the installation, fitting, commissioning and operating of frequency inverters and the possible hazards and in possession of qualifications matching their activities.

1.2 Proper use



Warning! The frequency inverters are electrical drive components intended for installation in industrial plants or machines. Commissioning and start of intended operation are not allowed until it has been established that the machine corresponds to the provisions of the EC machine directive 98/37/EEC and EN 60204. According to the CE sign, the frequency inverters additionally fulfill the requirements of the low-voltage directive 2006/95/EC and standards EN 50178/DIN VDE 0160 and EN 61800-2. Responsibility for compliance with the EMC directive 89/336/EEC is with the user. Frequency inverters are available in a limited way and as components exclusively intended for professional use within the meaning of the EN 61000-3-2.

With the issue of the UL according to UL508c, the requirements of the CSA Standard C22.2-No. 14-95 have also been fulfilled.

The technical data and the information on connection and ambient conditions the rating plate and the documentation be complied with. The instructions must be read and fully understood before starting work on the device.

1.3 Transport and storage

Transport and storage are to be carried out in an adequate way in the original packaging. Storage shall be in dry rooms protected against dust and moisture with slight temperature fluctuations. Please observe the climatic conditions according to EN 50178 and the marking on the packaging. The duration of storage without connection to the admissible reference voltage may not exceed one year.

1.4 Handling and installation



Warning! Damaged or destroyed components may not be put into operation because they may be a health hazard.

The frequency inverters are to be used according to the documentation, the directives and the standards. Handle carefully and avoid mechanical overload. Do not bend the components or change the isolation distances. Do not touch electronic components or contacts. The devices contain electrostatic sensitive components which can easily be damaged by improper handling. Any use of damaged or destroyed components shall be considered as a non-compliance with the applicable standards. Do not remove any warning signs from the device.

1.5 Electrical connection



Warning! Before any assembly or connection work, de-energize the frequency inverter. Make sure that the frequency inverter is de-energized. Do not touch the sockets, because the capacitors may still be charged. Comply with the information given in the operating instructions and on the frequency inverter label.

While working on the frequency inverters, obey the applicable standards BGV A2 (VBG 4), VDE 0100 and other national directives. Comply with the information in the documentation on electrical installation and the relevant directives. Responsibility for compliance with and examination of the limit values of the EMC product standard EN 61800-3 for variable-speed electrical drive mechanisms is with the manufacturer of the industrial plant or machine.

The documentation contains information on installation correct for EMC. The cables connected to the frequency inverters may not be subjected to an isolation test with a high test voltage without previous circuit measures.

1.6 Operating information



Warning! The frequency inverter may be connected to power supply every 60 s. Consider this for a jog operation of a mains contactor. For commissioning or after an emergency stop, a non-recurrent, direct restart is permissible. After a failure and restoration of the power supply, the motor may start unexpectedly if the AutoStart function is activated. Install protective equipment if personal injury or material damage is possible. Before commissioning and the start of the intended operation, attach all the covers and check the sockets. Check additional monitoring and protective devices pursuant to EN 60204 and the safety directives applicable in each case (e.g. Working Machines Act, Accident Prevention Directives etc.). No connection work may be performed, while the system is in operation.

1.7 Maintenance and servicing



Warning! Unauthorised opening and improper interventions can lead to physical injury or damage to property. Repairs on the frequency inverters may only be carried out by the manufacturer or persons authorised by the latter. Check protective equipment regularly.

2 Introduction

This document describes the protocol of the communication module CM-232 with RS232 port and CM-485 with RS485 port.

For the RS232 connection, the frequency inverter must be equipped with the RS232 communication module CM-232.

For the RS485 connection, the frequency inverter must be equipped with the RS485 communication module CM-485.

The communication modules CM-232 and CM-485 are separate components and must be mounted to the frequency inverter by the user. This is described in detail in chapter "Assembly".

Note: This document only describes the communication modules CM-232 and CM-485. It does not provide basic information on the serial interfaces RS232 and RS485. Neither does it contain any basic information on the operation of the frequency inverter.

Basic knowledge of the methods and function of the serial interfaces RS232 and RS485 is required in order to understand and use the instructions contained in this document.

Note: In some chapters of these instructions, setting and display options via the PC software VPlus are described as an alternative to the KP500 control unit. In this case, VPlus communicates with the frequency inverter

- via the module CM-232 or CM-485 **or**
- via the interface adapter KP232.

If the serial interface of the module CM-232/CM-485 is connected to a PLC, for example, VPlus cannot access the frequency inverter via this interface directly.

In this case, the PC must be connected via the optional interface adapter KP232.

Attention! Via the RS232 port at CM-232 or the RS485 port at CM-485, a controller can access **all** parameters of the frequency inverter.

Any change of parameters, the meaning of which is unknown to the user, may result in the frequency inverter becoming inoperative.

RS485 connection:

Frequency inverters can be connected to a bus system by extension with CM-485 communication modules. The bus structure is linear and designed as a 2-wire line. Via a bus master, up to 30 frequency inverters can be addressed.

The frequency inverters can be parameterized and controlled easily. Additionally, frequency inverter data can be polled and setting commands can be transmitted during operation via the bus system by means of a PC or a PLC.

RS232 connection:

The RS232 connection enables a peer-to-peer connection between two clients.

Note: The standardized designation of the interface is "EIA-232". In this documentation it is designated as RS232.

3 Installation/Disassembly of the communication module

3.1 Installation

The communication module is pre-assembled in a case. Additionally, a PE spring is enclosed for PE connection (shield).



Caution! The frequency inverter must be disconnected from power supply before installation of the communication module.
 Assembly under voltage is not permissible and will destroy the frequency inverter and/or the communication module.
 Do not touch the PCB visible on the back of the module, otherwise components may be damaged.

Work steps:

- Disconnect the frequency inverter from mains voltage and protect it against being energized unintentionally.
- Remove covers (1) and (2) of the frequency inverter. Slot B (4) for the communication module is now accessible.

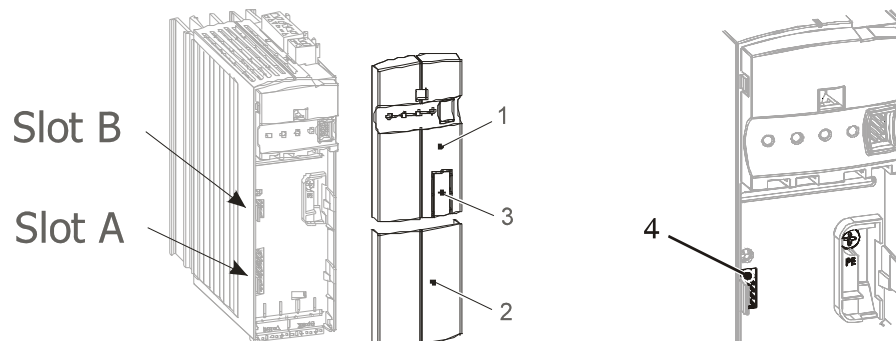

- Mount the supplied PE spring (5) using the M4 screw (6) in the unit. The spring must be aligned centrally.
- Insert the communication module in slot B (4) until it engages audibly.
- Fix the communication module by screwing the M2 screw (7) of the module to the PE spring (5).

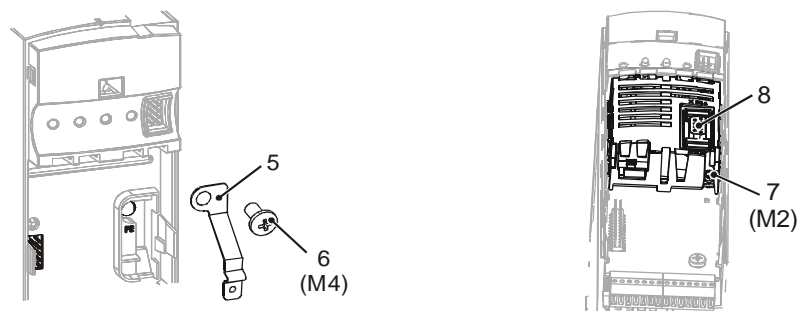

- In the upper cover (1), break out the pre-punched cutout (3) for the plug X310 (8).
- Mount the two covers (1) and (2).

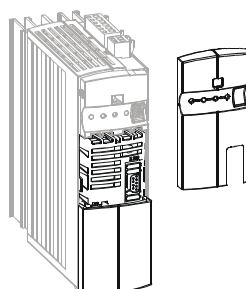

3.2 Disassembly

- Disconnect the frequency inverter from mains voltage and protect it against being energized unintentionally.
- Remove covers (1) and (2) of the frequency inverter.

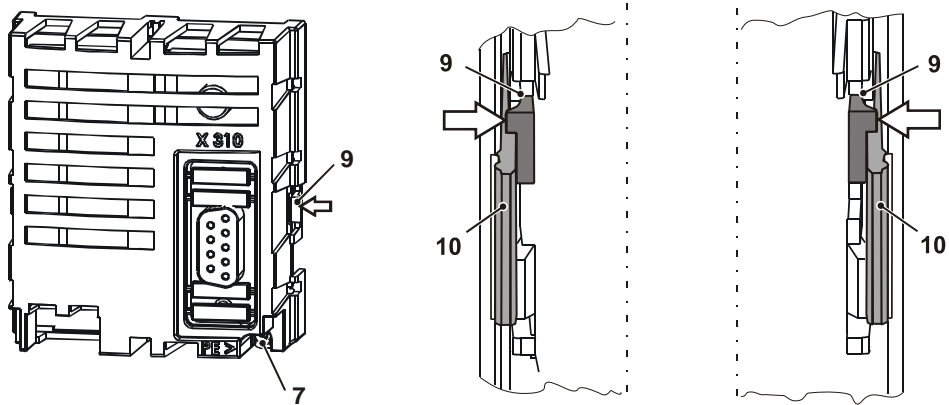

- Loosen the M2 screw (7) at the communication module
- Unplug the communication module from Slot B (4) by unlocking the locking hooks (9) on the right and left side of the module from the case of the frequency inverter using a small screwdriver.
The locking hooks (9) are located at the place where the locking hooks (10) for the upper cover (1) project from the case of the frequency inverter.
 - To do this, insert the screwdriver in the gap between the case of the module and the frequency inverter carefully and push the locking hook inwards in the direction of the arrow (⇐). As soon as the right side is unlocked, pull out the module a bit on the right side and hold it.
 - Hold the module on the right side while unlocking the locking hook on the left side in the same way (⇒).
 - Pull the module out of the slot by gently pulling on the right and left side alternately.
- Disassemble the PE spring (5).
- Mount the two covers (1) and (2).

4 Socket connection/bus termination/line

4.1 RS232 module CM-232

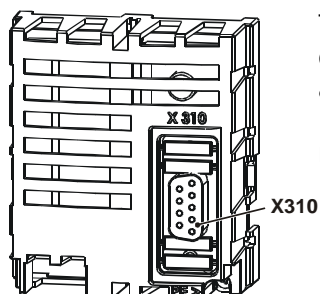

The RS232 interface is connected to a PC or a controller via the 9-pin D-Sub socket **X310**. The assignment complies with the standard, thus a RS232 connection cable (1:1) is required for connection only.

Part. no.
179 675-100

Bus Connector X310 CM-232 (9p Sub-D)

pin	name	function
Housing	Shield	connected with PE
1	–	n. c.
2	RxD	receive Data (input)
3	TxD	transmit Data (output)
4	–	n. c.
5	0 V	Ground
6	–	n. c.
7	–	n. c.
8	–	n. c.
9	–	n. c.

- If no pre-assembled connection cable is used for the RS232 connection, a twisted and shielded cable is to be used
- 1:1 assignment of the pin contacts
- The shield must be a harness shield (**not a foil shield**)
- The shield is to be connected to PE properly on both sides

4.2 RS485 module

- For the bus cable RS485, the twisted and shielded line is to be used
- The shield must be a harness shield (**not a foil shield**)
- The shield is to be connected to PE properly on both sides.
- The pin assignment of the RS485 cable is different from that of the RS232 cable; if you use the wrong cable, no communication is possible

4.2.1 RS485 module CM-485 DB9

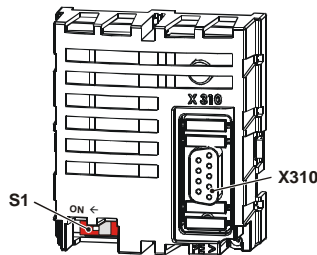

The RS485 interface is connected via the 9-pin D-Sub socket **X310**.

For details on the pin assignment, refer to the following table.

Part. No.
179 675-110

Bus Connector X310 CM-485 DB9

pin	name	function
Housing	Shield	connected with PE
1	Data Line B	short-circuit proof and functionally insulated; max. current 60 mA
2	Data Line B'	same as pin 1 – for cable network
3	0 V	GND/earth
4	–	n. c.
5	+5 V	Supply voltage interface converter +5 V
6	–	n. c.
7	Data Line A	short-circuit proof and functionally insulated; max. current 60 mA
8	Data Line A'	same as pin 7 – for cable network
9	–	n. c.

4.2.2 RS485 module CM-485 T

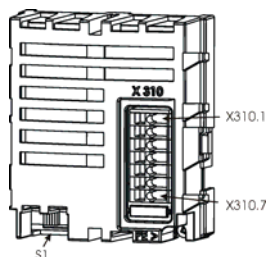

The RS485 interface is connected via the 7-pin terminal socket **X310**

For details on the pin assignment, refer to the following table.

Part. no.
179 675-111

Bus Connector X310 CM-485 T (7p terminal)

terminal	name	function
1	Data Line A	short-circuit proof and functionally insulated; max. current 60 mA
2	Data Line A'	same as terminal 1 – for cable network
3	Data Line B	short-circuit proof and functionally insulated; max. current 60 mA
4	Data Line B'	same as terminal 3 – for cable network
5	+5 V	Supply voltage interface converter +5 V
6	0 V	GND/ earth
7	PE	Shield/PE

4.2.3 Bus termination

Attention! The passive bus termination (connection of a termination resistor) is required at the physically first and last client. It can be activated by the DIP Switch S1 of the CM-232 and CM-485. This is a passive termination.

By default, the bus termination is set to **OFF**.

It is important to realize the correct termination. If not, no communication is possible by the RS485 interface!

As an alternative the active bus termination is possible via corresponding circuit :

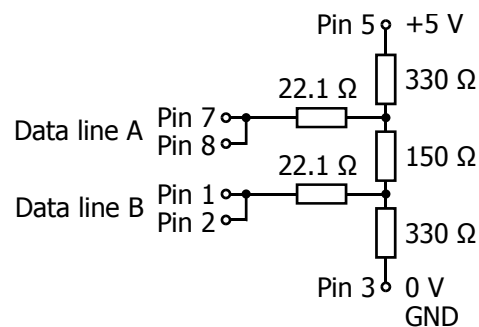

The active termination is only allowed once each branch. The bus termination via an external circuit and via DIP switch at the same time is not allowed.

Take care for the ground wiring; this will protect the communication bus for a high noise level.

For easy wiring the signal terminals A and B have parallel contacts.

Example of wiring with different CM-485 modules:

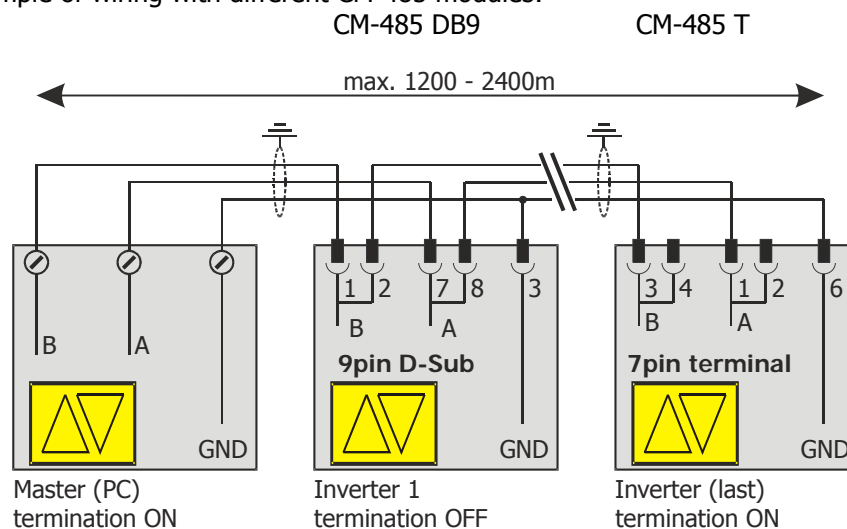

5 Startup

By default, the parameters of the communication modules CM-232 and CM-485 are set as follows:

Parameter		Settings
No.	Description	Factory setting
10	Baud Rate	4 - 19200 Baud
394	RS232/RS485 NodeID	1
395	Protocol	0 - VABus
900	Node-ID	-1

If other settings are required, the communication modules are to be configured via the corresponding software parameters.

The transmitter and receiver must be set to the same transmission rate (Baud rate). The NodeIDs must be different. Identical NodeIDs causes communication failures.

5.1 General Information on Configuration

The CM-232/CM-485 communication modules can be configured in different ways:

- **Direct connection CM-232 to the PC**

Direct connection between the 9-pin D-Sub socket (X310) of the CM-232 and the serial interface of a PC.

Configuration of the installed communication module via the control software VPlus or the control unit KP500.

In the case of the CM-232 the connection to the PC is realized via a RS232 connection cable (1:1).

- **Direct connection CM-485 to the PC**

Direct connection between the 9-pin D-Sub socket (X310) of the CM-485 and the serial interface of a PC via an interface converter.

Configuration of the installed communication module via the control software VPlus or the control unit KP500.

- **Connection of interface adapter KP232 to the PC**

Connection of the interface adapter KP232 at slot A of the frequency inverter. Connection to PC via a RS232 connection cable (1:1). Configuration of the installed communication module via the control software VPlus.

- **Configuration via Control Unit KP500**

Configuration via the pluggable control unit KP500 at slot A of the frequency inverter.

Attention! The transmitter and receiver must be set to the same transmission rate (Baud rate).

The setting of the Baud rate effects the communication of the modules CM-232 and CM-485. The KP232 interface adapter adjusts the Baud rate automatically to the PC or control transmission rate.

Work steps:

- Install module CM-232/CM-485 at the frequency inverter.
- **In the case of module CM-232:**
Connect CM-232 and PC via RS232 cable.
- **In the case of module CM-485:**
Connect CM-485 via RS485 cable with interface converter.
Connect the RS232 port of the interface converter with the PC.

or

- Plug in control unit KP500 or interface adapter KP232 at slot A of the frequency inverter.
- In the case of KP232: connect interface adapter KP232 to PC via a serial cable.

Protocol type settings

By default, the communication modules CM-232 / CM-485 are set to the BONFIGLIOLI VECTRON standard protocol (VABus). Only with this protocol type, a communication with the control software VPlus is possible.

Attention! If another protocol type or a wrong setting is selected, no communication is possible via CM-232/CM-485.
In this case, correct the protocol type using the control unit KP500.
For detailed information, see chapter 6, **Protocol**.

Note: For communication with ACT inverters the mains voltage must be applied.
For ACU inverters alternatively a 24 VDC external supply is sufficient.

Note: The interface adapter KP232 operates with the BONFIGLIOLI VECTRON standard protocol VABus independent of the communication module CM-232 or CM-485 and can communicate with VPlus at any time.

5.2 RS232 Module CM-232

5.2.1 Setting the Baud Rate

The transmission speed of the CM-232 is set via parameter *Baud Rate 10*.

The transmission speed of the CM-232 depends on various application-specific parameters. For example, the cable length limits the transmission speed due to signal propagation delays.

<i>Baud Rate 10</i>	Function	max. cable length ¹⁾
1 – 2400 Baud	Transmission rate 2400 Baud	30 m
2 – 4800 Baud	Transmission rate 4800 Baud	30 m
3 – 9600 Baud	Transmission rate 9600 Baud	30 m
4 – 19200 Baud	Transmission rate 19200 Baud	30 m
5 – 57600 Baud	Transmission rate 57600 Baud	10 m
6 – 115200 Baud	Transmission rate 115200 Baud	10 m

¹⁾ The indicated cable lengths are recommended maximum values which depend, among other things, on the quality of the cable.

Attention! Baud rate changes are only active after a reset of the frequency inverter via the software or Mains Off/On.

In the case of the software reset, proceed as follows:

- Via the control unit KP500 or the control software VPlus open parameter *Program(ming) 34*.
- Set parameter value "123".
- Confirm by pressing "ENT".

After the reset, the frequency inverter is initialized and is ready for operation after a few seconds.

5.2.2 Setting the Address

The address of the CM-232 can be set via parameter *RS232/RS485 NodeID 394*.

Parameter		Settings		
No.	Description	Min.	Max.	Fact. sett.
394	RS232/RS485 NodeID	1	30	1

Note: Normally, it is not necessary to change the default setting (Address 1). In the case of special operating conditions, the address can be adjusted.

Attention! An address change is effective immediately, i.e. without a restart of the frequency inverter.

For details on addressing, see chapter 6.3.1 „Representation of Address“.

5.3 RS485 Module CM-485

5.3.1 Setting the Baud Rate

The transmission speed of the CM-485 is set via parameter *Baud Rate 10*.

The transmission speed of the CM-485 depends on various application-specific parameters. For example, the cable length limits the transmission speed due to signal propagation delays. With additional repeaters the max. cable length can be increased.

<i>Baud Rate 10</i>	Function	max. line length
1 – 2400 Baud	Transmission rate 2400 Baud	2400 m
2 – 4800 Baud	Transmission rate 4800 Baud	2400 m
3 – 9600 Baud	Transmission rate 9600 Baud	1200 m
4 – 19200 Baud	Transmission rate 19200 Baud	1200 m
5 – 57600 Baud	Transmission rate 57600 Baud	600 m
6 – 115200 Baud	Transmission rate 115200 Baud	300 m

- Attention!**
- All bus clients must be set to the same baud rate.
 - Baud rate changes are only active after a reset of the frequency inverter via the software or Mains Off/On.
In the case of the software reset, proceed as follows:
 - Via the control unit KP500 or the control software VPlus open parameter *Program(ming) 34*.
 - Set parameter value "123".
 - Confirm by pressing "ENT".
 After the reset, the frequency inverter is initialized and is ready for operation after a few seconds.

5.3.2 Setting the Node Address

The node address of the CM-485 is set via parameter *RS232/RS485 NodeID 394*. Up to 30 frequency inverters can be used at the RS485 bus. The frequency inverters are assigned unambiguous addresses in the range from 1 to 30.

Parameter		Settings		
No.	Description	Min.	Max.	Fact. sett.
394	RS232/RS485 NodeID	1	30	1

- Attention!**
- For operation with the RS485 module CM-485, each client must be assigned an address.
 - Bus addresses may only be assigned once, i.e. no double assignments.
 - An address change is effective immediately, i.e. without a restart of the frequency inverter.

For details on addressing, see chapter 6.3.1 „Representation of Address“.

6 Protocol

The VABus protocol described in the following is the standard protocol of BONFIGLIOLI VECTRON. It defines and describes the communication via the serial interfaces RS232 / RS485. By default, the frequency inverters are set to the VABus protocol. Via parameter *Protocol 395*, you can check and set the protocol type:

<i>Protocol 395</i>	Function
0 - VABus	BONFIGLIOLI VECTRON standard protocol (default setting)
1 - P-Bus	Application-specific bus protocol ¹⁾
2 -Modbus- RTU	Comply with the dedicated Modbus manual.
3 - Modbus-ASCII	

Note ¹⁾ This bus protocol is only used for special applications. It cannot be used for standard applications. For more detailed information, refer to the application-specific instructions.

Caution ! – Changes of the parameter *Protocol 395* are effective immediately, i.e. without a restart of the frequency inverter.
 – If the wrong protocol is selected, communication via CM-232/CM-485 is not possible. In this case, correct the protocol type using the control unit KP500 or KP232 and VPlus.

The VABus protocol enables the operation as a pure Master/Slave system. A PC, a PLC or any type of computer system is the bus master.

The transmission protocol corresponds to the ISO standard 1745 for code-based information transfer and applies both to the communication modules CM-232 and CM-485.

Two types of requests are used:

- **Send request** (enquiry telegram) for the request for reading parameters in the frequency inverter by the bus master.
- **Setting request** (select telegram) for handing over parameter values or parameter settings to the frequency inverter by the bus master.

6.1 Character Format

The characters are based on 7-bit code according to DIN 66003 and consists of:

- 1 start bit
- 7 information bits (7 data bits B1...B7)
- 1 parity bit (= **even parity**)
- 1 stop bit

Character format:

Start	B1	B2	B3	B4	B5	B6	B7	Parity	Stop
-------	----	----	----	----	----	----	----	--------	------

The start bit is followed by the bit with the lowest valence.

6.2 Telegram Types

6.2.1 Symbols/Data Types Used

Control characters and data are transmitted in the sent data telegrams. The information is always represented in ASCII- or HEX-ASCII data format (except for the representation of the checksum).

Structure of a data telegram

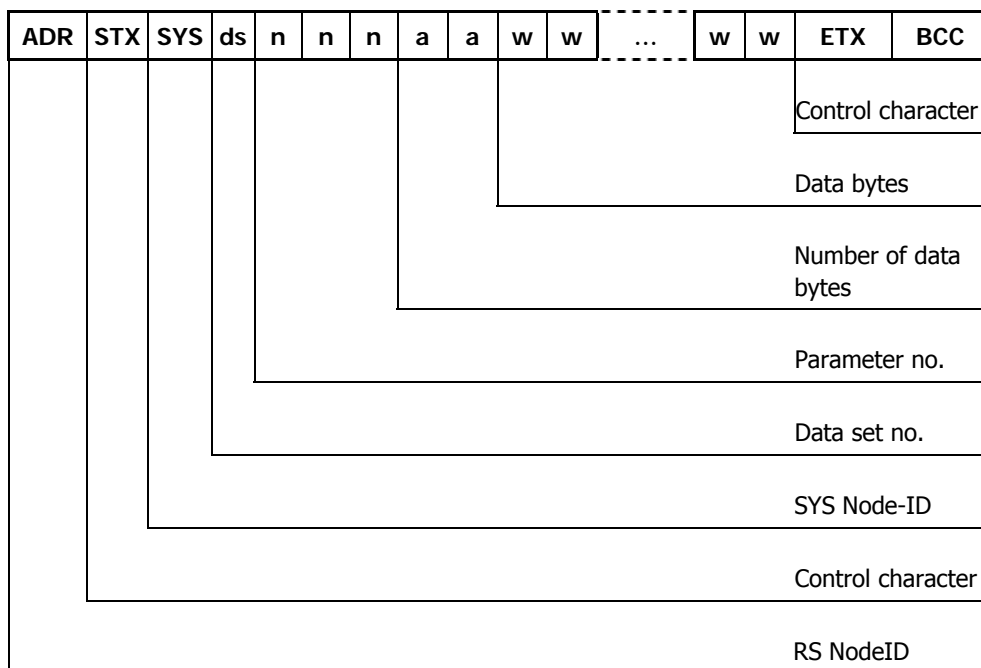

The following table describes the symbols and data formats used.

Characters in data telegram		
Characters	Function	
EOT	Control character End_Of_Transmission	
ADR	Address of the selected frequency inverter (Node-ID + 0x30), see chapter 6.3.1.	
STX	Control character Start_Of_Text	
SYS	System node-ID character (Node-ID + 0x40), see chapter 6.3.3.	
ds	Data set number	(0, 1, 2, 3 ... 9) ¹⁾
nnn	Parameter number	(000 .. .F99) ¹⁾
aa	Number of subsequent data bytes	(01 ... 99) ¹⁾
www...www	Data bytes	(0 ... F) ²⁾
ETX	Control character End_Of_Text	
ENQ	Control character Enquiry	
BCC	BCC Binary Checksum, any character, see chapter 6.3.8.	
ACK	Control character Acknowledge (positive acknowledgement)	
NAK	Control character Negative_Acknowledge (negative acknowledgement)	

¹⁾ = represented as ASCII decimal numbers

²⁾ = represented as ASCII-HEX numbers

6.2.2 Data types

The number of data bytes depends on the type of the corresponding parameter. A maximum of 99 data bytes can be transferred.

Data Types Used				
Data type	Type	Number of data types "w"	value range	bit's
uInt	unsigned Integer	4	0 ... +65535	16
Int	Integer	4	-32768 ... +32787	16
Long	Long	8	-2^{31} ... $+2^{31}-1$	32
String	char. set	variable, up to 99	-	variable

Note: Parameter values with decimal places are transferred without decimal point. Depending on the number of decimal places, the values are multiplied by 10, 100 or 1000. The number of decimal places for the corresponding parameters is set in the frequency inverter. In this way it is made sure that the sent parameter values are processed with the correct number of decimal places.

Example: **Frequency value with data type Long:**

Value to be transferred = 100.25 Hz. The numerical value transmitted in the telegram is 10025, which corresponds to 0x2729 in HEX format. Since the data type is **Long**, 8 bytes are transferred ("wwwwwwww").

→ 00002729

Example: **Current value with data type Int:**

The value to be transmitted is 10.3 A. The numerical value transmitted in the telegram is 103, which corresponds to 0x67 in HEX format. Since the data type is **Int**, 4 bytes are transferred ("wwww").

→ 0067

Also refer to chapter 8 "Example Telegrams".

6.2.3 Send Request / Enquiry Telegram

Via the enquiry telegram of the bus master, the frequency inverter is requested to send the data content of the relevant parameter. In the enquiry response telegram, the frequency inverter sends the requested data to the bus master. The master completes the transmission with EOT.

Bus Master → frequency inverter

EOT	ADR	SYS	ds	n	n	n	ENQ
-----	-----	-----	----	---	---	---	-----

Frequency inverter → Bus Master

ADR	STX	SYS	ds	n	n	n	a	a	w	w	w	w	w	w	ETX	BCC
-----	-----	-----	----	---	---	---	---	---	---	---	---	-----	-----	---	---	---	-----	-----

or in the case of an error:

ADR	NAK
-----	-----

Bus Master → frequency inverter

EOT

If no response from the frequency inverter is received within an adjustable response time (see chapter 6.5, "Monitoring Function (Timing/Watchdog)"), or if the frequency inverter returns incorrect data, the enquiry telegram is repeated three times (maximum of three transmissions possible).

NAK signals an error. An error may have different causes. Errors may be caused by transmission failures, incorrect data or an incorrect string.

Attention! After NAK the error register *VABus SST-Error-Register 11* must be read out (see chapter 6.4, "Telegram Check/Error Acknowledgement").

6.2.4 Setting Request / Select Telegram

Via the select telegram, the data is sent to the frequency inverter.

Bus Master → frequency inverter

EOT	ADR	STX	SYS	ds	n	n	n	a	a	w	w	w	...	w	w	w	ETX	BCC
-----	-----	-----	-----	----	---	---	---	---	---	---	---	---	-----	---	---	---	-----	-----

Frequency inverter → Bus Master

With ACK, the frequency inverter acknowledges that a valid string was received.

ADR	ACK
-----	-----

or in the case of an error:

ADR	NAK
-----	-----

Bus Master → frequency inverter

EOT

- Attention!**
- After NAK the error register *VABus SST-Error-Register 11* must be read out (see chapter 6.4, "Telegram Check/Error Acknowledgement").
 - Broadcast transmissions to address 32 are not acknowledged with ACK, NAK and EOT.
Generally, the bus master sends unconfirmed data telegrams in the case of broadcast transmissions.

6.3 Telegram frame

6.3.1 Representation of Address

Up to 30 frequency inverters can be used at a RS485 bus. These are assigned addresses 1...30.

Via address 32, all clients connected can be addressed simultaneously. Address 32 is also referred to as the Broadcast Address.

Attention! After a transmission to the Broadcast Address 32, there is no feedback (ACK or NAK) from the frequency inverters.

Address Codes					
num. address	ASCII char	hex. address	num. address	ASCII char	hex. address
1	A	41	16	P	50
2	B	42	17	Q	51
3	C	43	18	R	52
4	D	44	19	S	53
5	E	45	20	T	54
6	F	46	21	U	55
7	G	47	22	V	56
8	H	48	23	W	57
9	I	49	24	X	58
10	J	4A	25	Y	59
11	K	4B	26	Z	5A
12	L	4C	27	[5B
13	M	4D	28	\	5C
14	N	4E	29]	5D
15	O	4F	30	^	5E
			32**	`	60

** = Broadcast Address only of Master

6.3.2 Control Characters

The following control characters are used:

Control character		
Control character	Name	HEX value
EOT	End_Of_Transmission	04
ENQ	Enquiry	05
STX	Start_Of_Text	02
ETX	End_Of_Text	03
ACK	Acknowledge	06
NAK	Negative_Acknowledge	15

6.3.3 The system bus Node-ID

With the system bus *Node-ID 900* the master communicates with inverters which are connected by a network system. If no network is present or the master communicates directly with the RS485-master inverter the SYS character is all time zero (**0x30**). The system bus *Node-ID 900* has the value range of 0 to 63.

<i>Node-ID 900</i>	Function	SYS Zeichen
-1	No system bus connected to the inverter.	"-1" = 0xFFFF
0	The inverter is the system bus master.	„0" = 0x30
1 ... 63	The inverter is the system bus slave with the indicated ID.	0x41 ... 0x7F

If the *Node-ID 900* is unequal to zero the SYS character is calculated by the following formula:

$$\text{SYS char} = (\text{char})(\text{SYS Node ID} + 0x40)$$

Example: the *Node-ID 900* of 7 gives the char 0x47 = "G". For further information see the system bus manual.

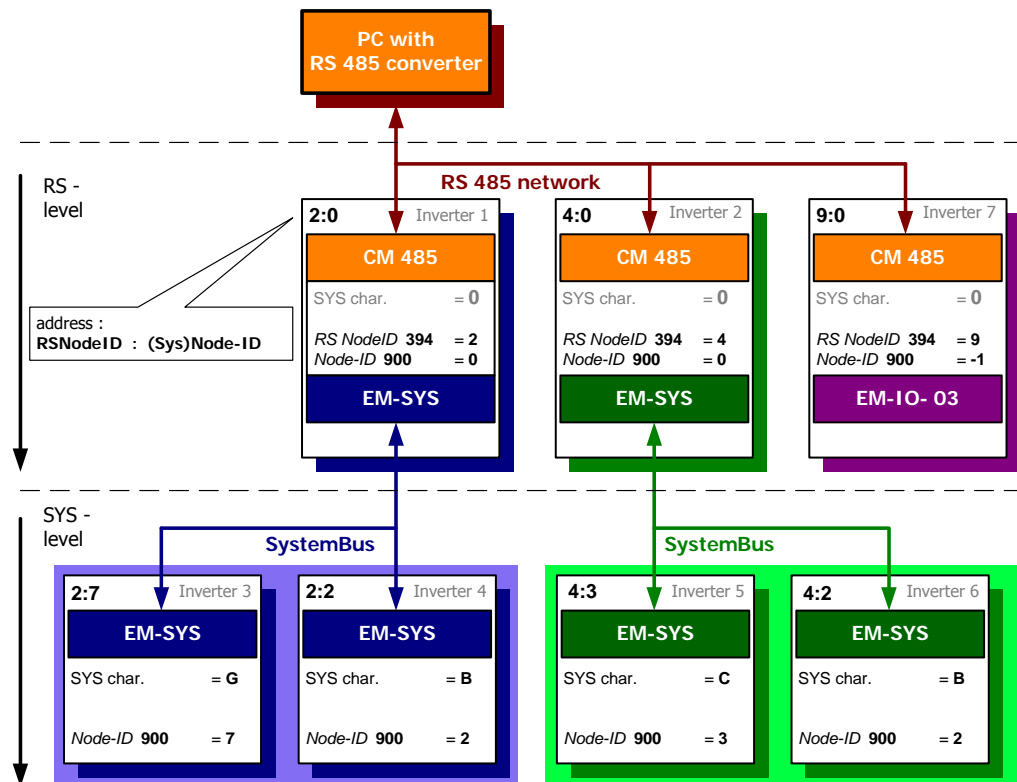

The addresses in a system bus branch must be assigned clearly. The RS485 system can access to several system bus branches so that identical system bus addresses are possible in the network, but only via different superior RS485 network subscribers.

6.3.4 Dataset

Depending on the information direction the limits are changing. The dataset number is transferred by a ASCII_character:

Data set			
direction	number	Char	target
master -> inverter	0 – 4	0x30 .. 0x34	EEPROM inverter
master -> inverter	5 - 9	0x35 .. 0x39	RAM inverter
inverter-> master	0 – 4	0x30 .. 0x34	-

6.3.5 Parameter number

The parameter number is transferred by three ASCII-characters. If the number is greater than 999, the first position (hundred) is converted to „A” to „F”.

Parameter number	
number	In the data frame
0 – 999	„000” .. „999”
1000 – 1099	„A00” .. „A99”
1100 – 1199	„B00” .. „B99”
...	...
1500 – 1599	„F00” .. „F99”

6.3.6 Data bytes

Numerical values are represented by ASCII-HEX characters. At first the value is converted to HEX notation and then, for each position transferred to ASCII characters.

example :

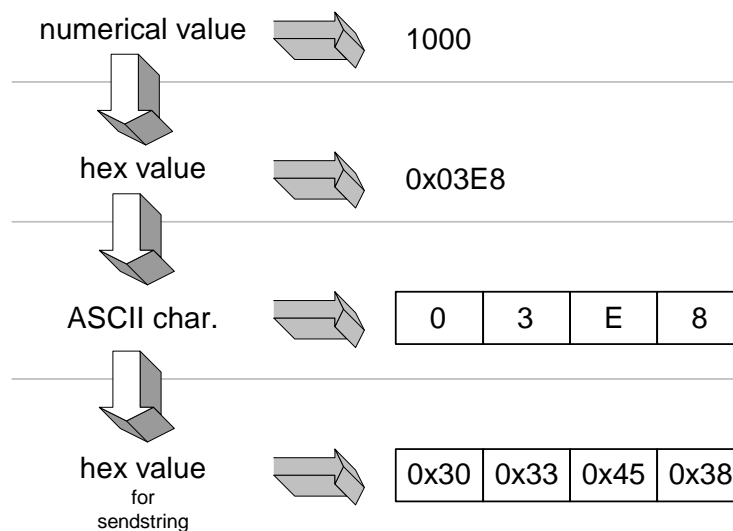

6.3.7 Control char ETX

Each data frame with parameter values is finished via the EXT character (0x03).

6.3.8 Binary Checksum (BCC)

The binary checksum (BCC) is made up of a byte which contains the ExOR operation of all bytes between STX (exclusive) and ETX (inclusive).

Send Request

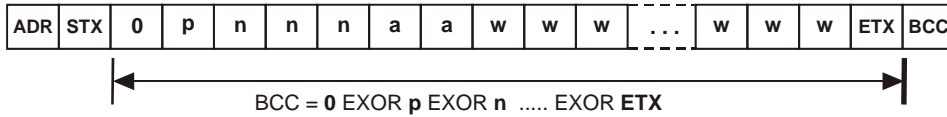

Setting Request

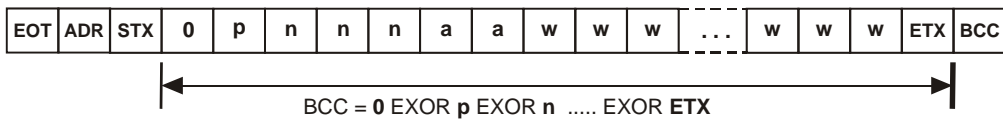

example : (see also example 8.2)

SYS Node-ID	= 0	= 0x30
Data set	= 2	= 0x32
parameter number	= 520	= 0x35 0x32 0x30
byte count (Int)	= 04	= 0x30 x034
num. value	= 1000	= 0x30 0x33 0x45 0x38

	SYS	ds	n	n	n	a	a	w	w	w	w	ETX
ASCII	0	2	5	2	0	0	4	0	3	E	8	-
hex-value	30	32	35	32	30	30	34	30	33	45	38	3

ExOR function over all characters in the data frame :

$$0x30 \wedge 0x32 = 0x02$$

$0x02 \wedge 0x35 = 0x37$
 $0x37 \wedge 0x32 = 0x05$
 $0x05 \wedge 0x30 = 0x35$
 $0x35 \wedge 0x30 = 0x05$
 $0x05 \wedge 0x34 = 0x31$
 $0x31 \wedge 0x30 = 0x01$
 $0x01 \wedge 0x33 = 0x32$
 $0x32 \wedge 0x45 = 0x77$
 $0x77 \wedge 0x38 = 0x4F$
 $0x4F \wedge 0x03 = 0x4C$

example of ExOR operation for the first two characters :

```

0011 0000 = 0x30
0011 0010 = 0x32
--- ExOR -----
0000 0010 = 0x02
    
```

the BCC is calculated to character „L“ = 0x4C

6.4 Telegram Check/Error Acknowledgement

The frequency inverter and the bus master check the telegrams for correctness. Depending on the type of telegram, the corresponding reaction takes place. The telegrams are checked for correct syntax, address and text part (content, checksum).

In case the telegram contains errors, the frequency inverter either returns NAK or it does not respond at all. The possible causes are listed below:

- no response**
- wrong telegram structure
 - wrong control character
 - wrong address
 - telegram addressed to address 32 (Broadcast); in this case, the frequency inverter does not reply.
- NAK**
- see table Error Messages

If a transmission (enquiry or select telegram) is answered by the frequency inverter with NAK, the error register *VABus SST-Error-Register 11* of the interface must be read out before a new **select telegram** is sent.

<i>VABus SST-Error-Register 11</i>	
Error no.	Meaning
0	no error
1	inadmissible parameter value
2	inadmissible data set
3	parameter not readable (write-only)
4	parameter not writable (read-only)
5	read error EEPROM
6	write error EEPROM
7	checksum error EEPROM
8	parameter cannot be written while the drive is running
9	values of the data sets differ from one another
10	wrong parameter type
11	unknown parameter
12	checksum error in received telegram
13	syntax error in received telegram
14	data type of parameter does not correspond to the number of bytes in the telegram
15	unknown error

When the error register *VABus SST-Error-Register 11* is read out, it is deleted at the same time.

Attention! The frequency inverter will not accept a new select telegram before the error register has been read.
 Enquiry telegrams will be accepted and answered.

6.5 Monitoring Function (Timing/Watchdog)

The protocol defines a pure Master/Slave operation. If a frequency inverter is addressed by the bus master, other frequency inverters will only be addressed after the protocol with the first frequency inverter has been completed or the Timeout time has expired.

After a frequency inverter has sent a telegram, a waiting time of 2 ms must be kept. This time is needed by the frequency inverter in order to switch off the RS485 transmitter. The bus master may not send a new telegram before this time has elapsed.

The frequency inverter replies 10 ms after receipt of a telegram, at the earliest. This means that the bus master must have switched off its RS485 transmitter after 10 ms, at the latest.

If the bus master does not receive an answer from the frequency inverter within 500 ms, it can start a new transmission to any frequency inverter.

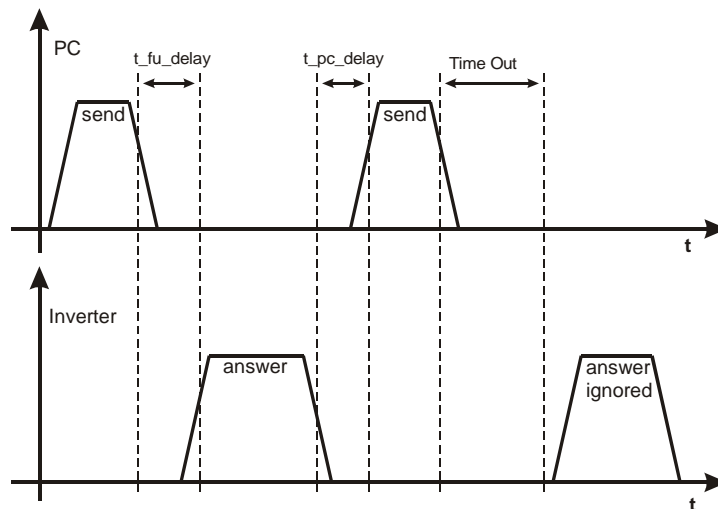

Attention! If the degree of utilization of the CPU is high (> 90%), the response time can be more than 500 ms

Note: The specified times are valid for operation with RS485 and RS232.

If the frequency inverter has not received a character after 500 ms, it rejects the character string received so far and waits for a new transmission.

If the frequency inverter is operated via the serial interface (RS232, RS485), it may be important to monitor the presence of the communication line. For example it may be that the frequency inverter is switched on/off in Remote Mode, or it only receives its reference value cyclically via the serial interface. If the communication fails, no or faulty data are transmitted. This is recognized by the communication watchdog.

The watchdog function monitors the time in which no correct communication takes place. This time can be adjusted via parameter *RS232/RS485 Watchdog Timer 413*. The adjusted value is the time in seconds (0...10000 seconds) within which at least one correct exchange of data must have occurred.

If the adjusted monitoring time has elapsed, the frequency inverter signals a fault. The fault message **F2010 Watchdog RS232/RS485** is displayed.

Parameter		Settings		
No.	Name/Meaning	Min.	Max.	Fact. Set.
413	RS232/RS485 Watchdog Timer [sec]	0	10000	0

Note: If parameter *RS232/RS485 Watchdog Timer 413* is set to 0 (default), the monitoring function is deactivated.

6.6 Block access

If a number of parameters are to be transmitted regularly block by block a block transmission can be carried out using the pseudo parameter described here. Since this type of block transmission only requires one communication overhead it can be carried out faster and may be easier to implement. The error evaluation and diagnosis for this block access is more difficult than for a separate parameter access.

The block definition has to be written in the parameter *Block definition 017* before a block transmission can be carried out. (This block definition is only saved until the next Reset.) A block can then be written on the parameter *Write block 018* and/or read from the parameter *Read block 019*. Only parameters of the type word and/or double word can be transferred during block transmission. The check sum is calculated (like a separate parameter access) from SYS and ETX (both inclusively). Each transmission is responded by the frequency inverter with ACK or NAK.

- Parameter *Block definition 017*
 The block definition is a string containing the parameter numbers of the parameters in the block as five-digit decimal figures in succession.
 The digits have the following functions:
 1. Digit S: System bus node (see chapter 6.3.3 "The system bus Node-ID")
 2. Digit d: Data set number
 - Digit 3 to 5: Parameter number
 The block can have a maximum string length of 80 characters.
 SdnnnSdnnn ... Sdnnn

- Parameter *Write block 018*
 Parameter *Read block 019*
 The data block is a string containing the values of the parameters in a ASCII-Hex form in succession.
 The maximum string length is 80 characters, enabling the transmission of blocks of up to 20 parameters of the type "word" (each with 4 Hex digits). If the block contains parameters of the type double word (each with 8 Hex digits) the number of parameters which can be transmitted in a block is reduced accordingly.

Examples of a block transmission:

Read parameters *Stator frequency 210* (FS), *R.m.s current 211* (I RMS) and *Active power 213* (PW), each from data set 0.

Parameter string for *Write Parameter 017*: "002100021100213"
 Parameter string for *Read Parameter 019*: "00002A5D00660028"

Set parameter 017 Master → Frequency inverter

	EOT	ADR	STX	SYS	ds	n	n	n	a	a	w	w	w	w	w	w	w	w	w	w	w	w	w	w	w	w	ETX	BCC
ASCII	♦	A	•	0	0	0	1	7	1	5	0	0	2	1	0	0	0	2	1	1	0	0	2	1	3	♥		
Hex-values	04	41	02	30	30	30	31	37	31	35	30	30	32	31	30	30	30	32	31	31	30	30	32	31	33	♥	00	

Enquiry telegram master → frequency inverter

	EOT	ADR	SYS	ds	n	n	n	ENQ
ASCII	◆	A	0	0	0	1	9	♣
Hex-values	04	41	30	30	30	31	39	05

Response frequency inverter → master

	ADR	STX	SYS	ds	n	n	n	a	a	w	w	w	w	w	w	w	w	w	w	w	w	w	w	w	w	ETX	BCC
ASCII	A	●	0	0	0	1	9	1	6	0	0	0	0	2	A	5	D	0	0	6	6	0	0	2	8	♥	4
Hex-values	41	02	30	30	30	31	39	31	36	30	30	30	32	41	35	44	30	30	36	36	30	30	32	38	♥	34	

Parameter	Data type	Hex-value	Decimal Result
210 Stator frequency	Double word = 8 hex-digits	00002A5D _{hex}	10845 _{dec} 108.45 Hz
211 R.m.s current	Word = 4 Hex-digits	0066 _{hex}	102 _{dec} 10.2 A
213 Active power	Word = 4 Hex-digits	0028 _{hex}	40 _{dec} 4.0 kW

Write the parameters *Fixed Frequency 2 481 (FF2)* and *Fixed Frequency 3 482 (FF3)* in data set 1.

Values:

FF2 (double word = 8 hex-digits) = 123.50 Hz, 12350_{dec} = 0000303E_{hex}
 FF3 (double word = 8 hex-digits) = 43.45 Hz, 4345_{dec} = 000010F9_{hex}

Write parameter 017: "0148101482"

Write parameter 018: "0000303E000010F9"

Set parameter 017 master → frequency inverter

	EOT	ADR	STX	SYS	ds	n	n	n	a	a	w	w	w	w	w	w	w	w	w	w	w	w	w	w	w	ETX	BCC
ASCII	◆	A	●	0	0	0	1	7	1	0	0	1	4	8	1	0	1	4	8	2	♥	5					
Hex-values	04	41	02	30	30	30	31	37	31	30	30	31	34	38	31	30	31	34	38	32	♥	37					

Set parameter 018 master → frequency inverter

	EOT	ADR	STX	SYS	ds	n	n	n	a	a	w	w	w	w	w	w	w	w	w	w	w	w	w	w	w	w	w	ETX	BCC
ASCII	◆	A	●	0	0	0	1	8	1	6	0	0	0	0	3	0	3	E	0	0	0	0	1	0	F	9	♥	6	
Hex-values	04	41	02	30	30	30	31	38	31	36	30	30	30	33	30	33	44	30	30	30	30	31	30	45	39	♥	36		

Note: For the read access of data set-dependent parameters Bonfiglioli Vectron recommends to inquire the parameters separately for each data set. If a data set-dependent parameter with data set 0 (= all data sets) is inquired and the values in the data sets are different from each other the response of the frequency inverter must be evaluated accordingly. A fail operation can be recognized by the number of bytes = 99.

With block transmission parameters with data type "string" can not be transmitted.

7 Handling of Data Sets/Cyclic Writing

Access to the parameter values is done on the basis of the parameter number and the required data set.

There are parameters the values of which exist once (data set 0) as well as parameters the values of which exist four times (data set 1...4). These are used for data set change-over.

If parameters which exist four times in the data sets are set to data set = 0, all four data sets are set to the same value.

A read access with data set = 0 to such parameters is only successful if all four data sets are set to the same value. If this is not the case, error 9 = "different values in data sets" is signaled via the error register *VABus SST Error Register 11*. In this case, you must read out each data set separately for the relevant parameter (see chapter 6.4 "Telegram Check/Error Acknowledgement").

New setting requests (select telegrams) will be blocked by the error register *VABus SST Error Register 11*. For this reason, the error register must be read out, i.e. acknowledged, before a new select telegram can be sent.

Regardless of the signal status of the error register, reading access (enquiry telegrams) is still possible.

The values are entered into the EEPROM automatically on the controller. If values are to be written cyclically at a high repeat rate, there must be no entry into the EEPROM, as it only has a limited number of admissible writing cycles (about 1 million cycles).



Caution! If the number of admissible writing cycles is exceeded, the EEPROM is destroyed.

In order to avoid the destruction of the EEPROM, data which are to be written cyclically can be entered in the RAM exclusively without a writing cycle on the EEPROM. In this case, the data are volatile, i.e. they are lost when the supply voltage is switched off (Mains Off). They must be written into the RAM again after the restart (Mains On). The RAM writing operation is activated by increasing the number of the target data set by five.

Exceptions are the parameters *Control Word 410*, *Reference Frequency RAM 484* and *Reference Percentage RAM 524*. These parameters will be written into the RAM although their addresses are always 0.

Access to the data sets of the frequency inverter

Parameter	EEPROM	RAM
Data set 0	0	5
Data set 1	1	6
Data set 2	2	7
Data set 3	3	8
Data set 4	4	9

Note: Via the control software VPlus and the control unit KP500 you can view the data sets in the EEPROM but not the data sets in the RAM.

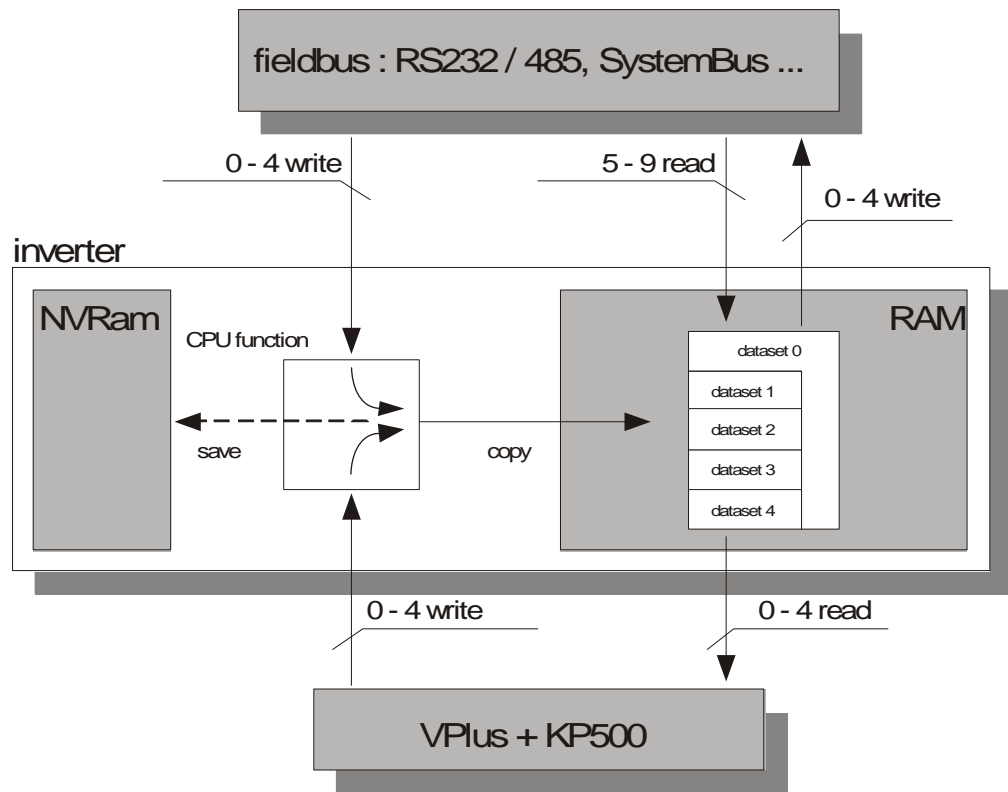

8 Example Telegrams

8.1 Data Type uInt (value range 0 ... 65535)

Example 1:

Reading of parameter *Rated Speed* **372** in data set 2 from the frequency inverter with address 1

Enquiry telegram master → frequency inverter

	EOT	ADR	SYS	ds	n	n	n	ENQ
ASCII	◆	A	0	2	3	7	2	♣
Hex values	04	41	30	32	33	37	32	05

Reply frequency inverter → Master

	ADR	STX	SYS	ds	n	n	n	a	a	w	w	w	w	ETX	BCC
ASCII	A	●	0	2	3	7	2	0	4	0	5	6	E	♥	E
Hex values	41	02	30	32	33	37	32	30	34	30	35	36	45	03	45

The sent hexadecimal value is 0x056E = decimal 1390. Parameter *Rated Speed* **372** has no decimal places.

Thus, the rated speed is 1390 min⁻¹.

Example 2:

Writing of parameter *Rated Mech. Power* **376** in data set 4 to the frequency inverter with address 3.

The rated mechanical power is to be set to 1.5 kW. Parameter *Rated Mech. Power* **376** has one decimal place.

Thus the value to be sent is 15, hexadecimal 0x000F.

Select telegram master → frequency inverter

	EOT	ADR	STX	SYS	ds	n	n	n	a	a	w	w	w	w	ETX	BCC
ASCII	◆	C	●	0	4	3	7	6	0	4	0	0	0	F	♥	G
Hex values	04	43	02	30	34	33	37	36	30	34	30	30	30	46	03	47

Reply frequency inverter → Master

	ADR	ACK
ASCII	C	♠
Hex values	43	06

In the case of an error, the reply would have resulted in a NAK.

	ADR	NAK
ASCII	C	§
Hex values	43	15

8.2 Data Type Int (value range -32768 ... +32767)

Example 1:

Reading of parameter *Fixed Percentage 1 520* in data set 2 from the frequency inverter with address 10

Enquiry telegram master → frequency inverter

	EOT	ADR	SYS	ds	n	n	n	ENQ
ASCII	◆	J	0	2	5	2	0	♣
Hex values	04	4A	30	32	35	32	30	05

Reply frequency inverter → Master

	ADR	STX	SYS	ds	n	n	n	a	a	w	w	w	w	ETX	BCC
ASCII	J	☺	0	2	5	2	0	0	4	0	3	E	8	♥	L
Hex values	4A	02	30	32	35	32	30	30	34	30	33	45	38	03	4C

The sent hexadecimal value is 0x03E8 = decimal 1000. Parameter *Fixed Percentage 1 520* has two decimal places.

Thus the reference percentage 1 = 10.00 %.

Example 2:

Writing of parameter *Fixed Percentage 4 376* in data set 0 to the frequency inverter with address 30.

The reference percentage 4 is to be set to 70.05 %. Parameter *Fixed Percentage 4 523* has two decimal places.

Thus the value to be sent is 7005, hexadecimal 0x1B5D.

Select telegram master → frequency inverter

	EOT	ADR	STX	SYS	ds	n	n	n	a	a	w	w	w	w	ETX	BCC
ASCII	◆	^	☺	0	0	5	2	3	0	4	1	B	5	D	♥	1
Hex values	04	5E	02	30	30	35	32	33	30	34	31	42	35	44	03	31

Reply frequency inverter → Master

	ADR	ACK
ASCII	^	♠
Hex values	5E	06

In the case of an error, the reply would have resulted in a NAK.

	ADR	NAK
ASCII	^	§
Hex values	5E	15

8.3 Data Type Long (value range $-2^{31} \dots +2^{31}-1$)

Example 1:

Reading of parameter *Fixed Frequency 2 481* in data set 0 from the frequency inverter with address 1.

Enquiry telegram master → frequency inverter

	EOT	ADR	SYS	ds	n	n	n	ENQ
ASCII	◆	A	0	0	4	8	1	♣
Hex values	04	41	30	30	34	38	31	05

Reply frequency inverter → Master

	ADR	STX	SYS	ds	n	n	n	a	a	w	w	w	w	w	w	w	w	w	ETX	BCC
ASCII	A	☺	0	0	4	8	1	0	8	0	0	0	0	0	3	E	8	♥	H	
Hex values	41	02	30	30	34	38	31	30	38	30	30	30	30	30	33	45	38	03	48	

The sent hexadecimal value is 0x03E8 = decimal 1000. Parameter *Fixed Frequency 2 481* has two decimal places.

Thus, fixed frequency 2 = 10.00 Hz.

Example 2:

Writing of parameter *Fixed Frequency 1 480* in data set 0 to the frequency inverter with address 1

Fixed frequency 1 is to be set to -120.00 Hz. Parameter *Fixed Frequency 1 480* has two decimal places. Thus the value to be sent is -12000, hexadecimal 0xFFFFD120.

Select telegram Master → frequency inverter

	EOT	ADR	STX	SYS	ds	n	n	n	a	a	w	w	w	w	w	w	w	w	ETX	BCC
ASCII	◆	A	☺	0	0	4	8	0	0	8	F	F	F	F	D	1	2	0	♥	@
Hex values	04	41	02	30	30	34	38	30	30	38	46	46	46	46	44	31	32	30	03	40

Reply frequency inverter → Master

	ADR	ACK
ASCII	A	♠
Hex values	41	06

In the case of an error, the reply would have resulted in a NAK.

	ADR	NAK
ASCII	A	§
Hex values	41	15

8.4 Data Type String (max. 99 characters)

Example 1:

Reading of parameter *User Name 29* in data set 0 from the frequency inverter with address 1

Enquiry telegram master → frequency inverter

	EOT	ADR	SYS	ds	n	n	n	ENQ
ASCII	◆	A	0	0	0	2	9	♣
Hex values	04	41	30	30	30	32	39	05

Reply frequency inverter → Master

	ADR	STX	SYS	ds	n	n	n	a	a	w	w	w	w	w	w	w	w	w	ETX	BCC
ASCII	A	☺	0	0	0	2	9	0	7	V	e	c	t	r	o	n	♥	h		
Hex values	41	02	30	30	30	32	39	30	37	56	65	63	74	72	6F	6E	03	68		

The sent string for parameter *User Name 29* reads "Vectron".

Example 2:

Writing of parameter *User Name 29* in data set 0 to the frequency inverter with address 1

The user name is to be set to "Inverter_17".

	EOT	ADR	STX	SYS	ds	n	n	n	a	a	w	w	w	w	w	w	w	w	w	w	ETX	BCC	
ASCII	◆	A	☺	0	0	0	2	9	1	1	I	n	v	e	r	t	e	r	_	1	7	♥	D
Hex values	04	41	02	30	30	30	32	39	31	31	49	6E	76	65	72	74	65	72	5F	31	37	03	44

Reply frequency inverter → Master

	ADR	ACK
ASCII	A	♠
Hex values	41	06

In the case of an error, the reply would have resulted in a NAK.

	ADR	NAK
ASCII	A	§
Hex values	41	15

9 ACT Inverter Control/Reference Value

The frequency inverter can be controlled completely via the serial interface. The following parameters and actual values are used for this:

Parameter		Settings			
No.	Name/Meaning	min.	max.	fact. sett.	type
410	Control Word	0x0000	0xFFFF	–	uInt
411	Status Word	0x0000	0xFFFF	–	uInt
484	Reference Frequency RAM [Hz]	-999.99	999.99	0.00	Long
524	Reference Percentage RAM [%]	-300.00	300.00	0.00	Long

With the *Control Word 410* (data type uInt), control commands are sent to the frequency inverter, with the *Reference Frequency RAM 484* (data type Long [Hz]) or *Reference Percentage RAM 524* (data type Long [%]), the reference line value is sent. Via the *Status Word 411* (data type uInt), the status of the frequency inverter is read out.

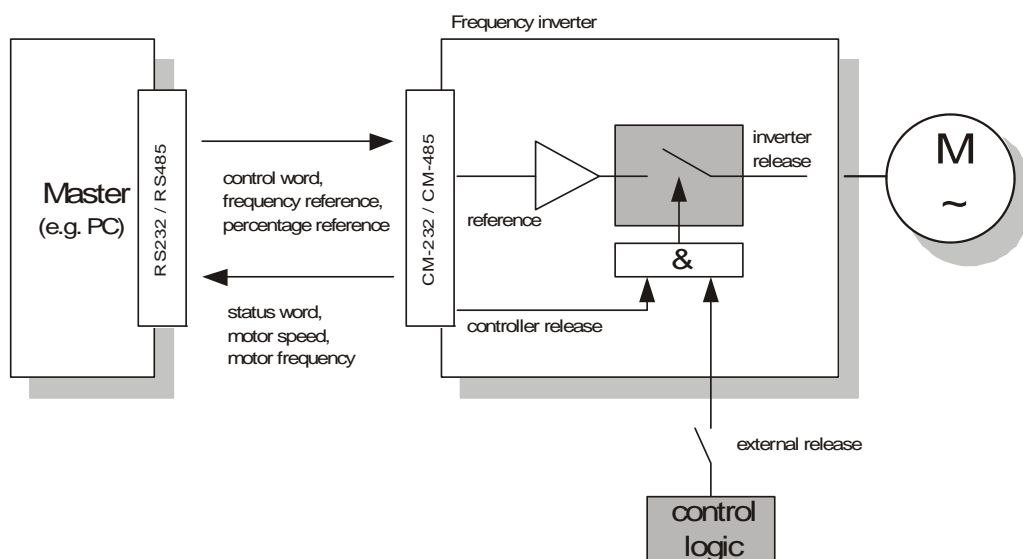

Note: *Control Word 410, Reference Frequency RAM 484 and Reference Percentage RAM 524* are stored in the RAM of the frequency inverter. This is generally addressed via data set 0.

Note: **External release:**

- With the ACT inverter the external release is done with a high logic signal at the input S1IND.
- This digital input has the highest priority and has to be hard-wired.

The frequency inverter can be controlled via three different operation modes. These operation modes set via parameter *Local/Remote 412*.

<i>Local/Remote 412</i>	Supported Operation Modes
0 - Control via Contacts	The Start and Stop commands as well as the direction of rotation are controlled via digital signals.
1 - Control via State-machine	The Start and Stop commands as well as the direction of rotation are controlled via the DRIVECOM Statemachine ¹⁾ of the communication interface.
2 - Control via Remote Contacts	The Start and Stop commands as well as the direction of rotation are controlled via virtual digital signals through the communication protocol.

Note: ¹⁾ Statemachine is a standardized software module within the controller of the frequency inverter. The Statemachine maps specified operating statuses and the controller within the frequency inverter.

- Note:**
- For operation via the serial interface, settings 0, 1 and 2 are relevant. Further possible operation modes *Local/Remote 412* are described in the frequency inverter operating instructions. These relate to the control via the control unit KP500 and the control via digital signals.
 - Parameter *Local/Remote 412* is data set related, i.e. by selecting a data set, you can switch over between the different operation modes.

For example, it is possible to control the frequency inverter via the serial interface and to activate a local emergency operation mode if the controller fails. This switch-over is also visible via the status word in bit "Remote".

The data set switch-over can be effected via control contacts at the digital inputs of the frequency inverter or via the bus. For data set change-over via the bus, parameter *Data Set Selection 414* is used.

Parameter		Settings		
No.	Name/Meaning	Min.	Max.	Fact. Set.
414	Data Set Selection	0	4	0

With the default setting *Data Set Selection 414* = 0, the data set change-over is done via the digital inputs.

If *Data Set Selection 414* is set to 1, 2, 3 or 4, the selected data set is activated via the bus. At the same time, data set change-over via the digital inputs is deactivated.

Via parameter *Active Data Set 249*, the currently selected data set can be read out. This is independent of whether the data set change-over was done via the digital inputs or via *Data Set Selection 414*.

9.1 Control

9.1.1 Control via Contacts

In the operation mode "Control via Contacts" (*Local/Remote* **412** = 0), the frequency inverter is addressed via the digital inputs S1IND ... S6IND, the multifunction input MFI1D as well as the additional inputs EM-S1IND...EM-S3IND (optional expansion modules).

The function of these inputs is described in the frequency inverter operating instructions and the expansion module operating instructions.

Note: If the frequency inverter is addressed via digital inputs S1IND...S6IND, addressing via the *Control Word* **410** is not used in this operation mode.

Sequence in Statemachine:

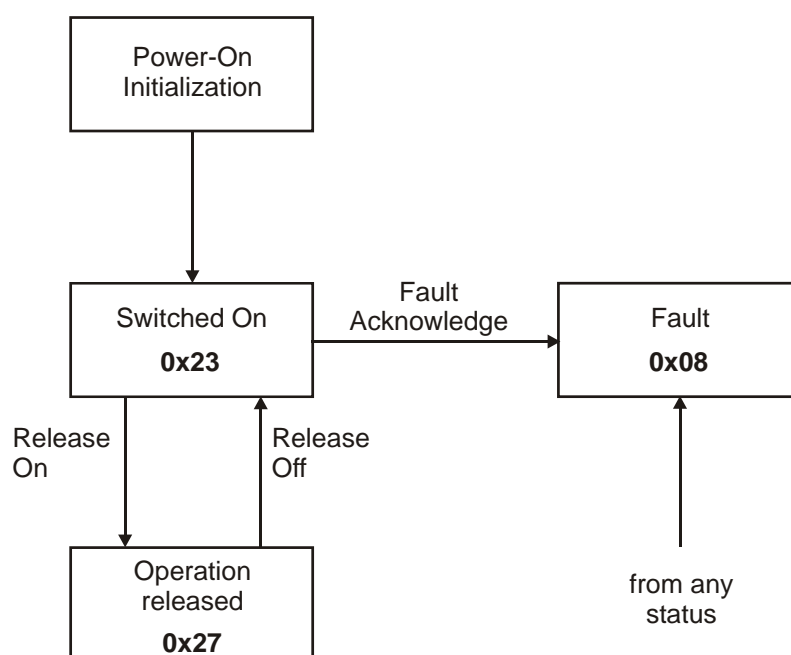

The numbers indicated in the individual operating statuses (e.g. **0x23**) signal the corresponding feedback (e.g. switched on) via the status word (bit 0...6).

The parameter *Status Word 411* has a length of 16 bits. The set bits have the following meaning:

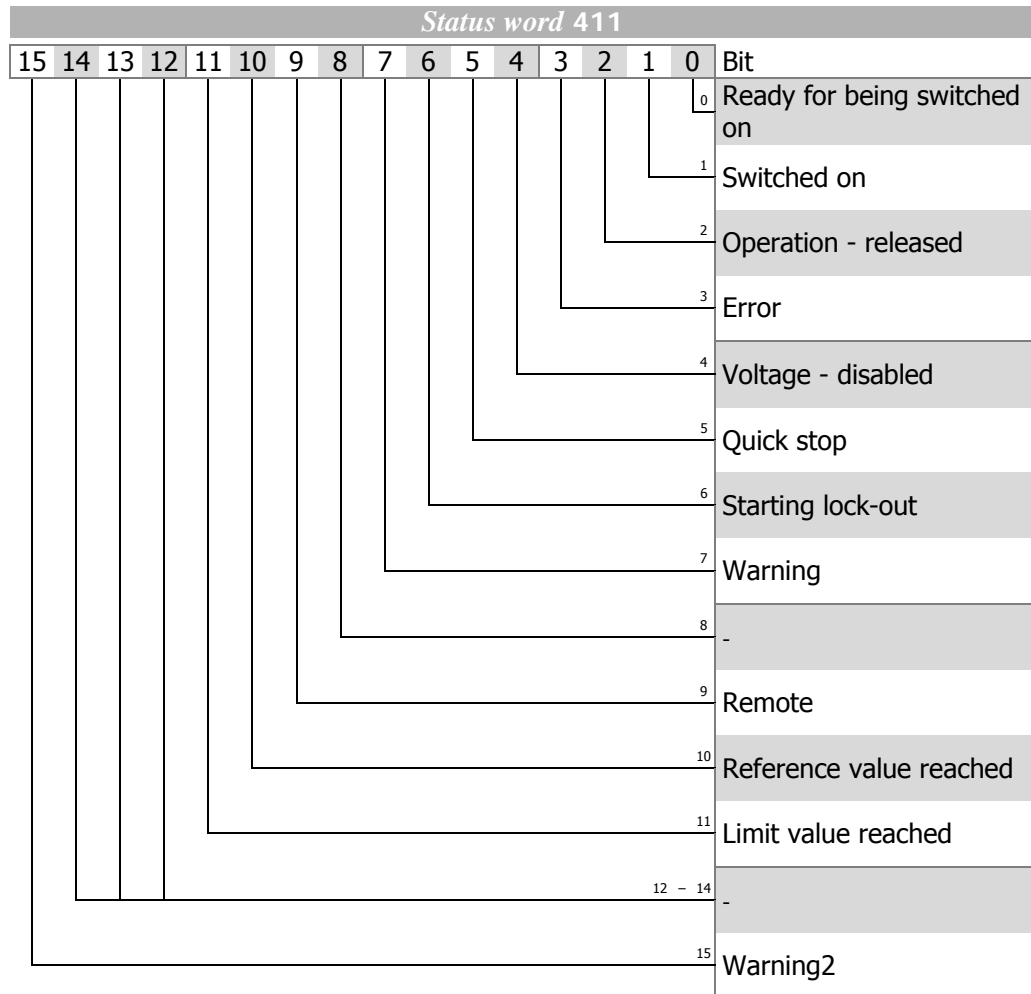

The status word reflects the operation state.

Status word	HEX ¹⁾	Bit 6	Bit 5	Bit 3	Bit 2	Bit 1	Bit 0
Switched on	0x23	0	1	0	0	1	1
Operation released	0x27	0	1	0	1	1	1
Error	0x08	0	X ²⁾	1	0	0	0

¹⁾ without consideration of bits 7...15!

²⁾ "X" means any value ("0" or "1")

If a fault occurs, the fault status is activated.

Note: A fault can only be acknowledged 15 seconds after the occurrence of the fault, i.e. after the internal blocking time has elapsed.

If a fault has occurred, the cause of the fault can be read out via parameter *Current Error 260*.

Status Word Bit 7 to Bit 15

Bit 7, "Warning bit"

The **warning bit "7"** can signal an internal warning and results in the frequency inverter being switched off, depending on the cause.

The evaluation of the warning is done by reading out the warning status via parameter *Warnings* **270**.

Bit 9, "Remote"

The **remote bit** is always set to 0 in the case of the control via contacts.

Bit 10, "Reference value reached"

The bit **"Reference value reached"** is set when the specified reference value is reached. In the special case of power failure regulation, the bit is also set when the power failure regulation reaches the frequency 0 Hz (see frequency inverter operating instructions).

For "Reference value reached" there is a hysteresis (tolerance range) which can be set via the parameter *Max. Control Deviation* **549** (see frequency inverter operating instructions).

Bit 11 "Limit active"

The bit **Limit value active** indicates that an internal limit is active. This may be the current limit, the torque limit or the overvoltage control. All functions result in the reference value being left or not reached.

Bit 15 "Warning2"

The bit **"Warning2"** extends bit 7 "Warning bit" by the following information:

Bit 15 signals a critical operating state which will result in a fault switch-off of the frequency inverter within a short time. This bit is set if there is a delayed warning relating to the motor temperature, heat sink/inside temperature, Ixt monitoring or mains phase failure.

If **bit 15** is set, **bit 7** is set, too.

9.1.2 Control via Control Word of Statemachine

In this operation mode (*Local/Remote* 412 = 1), the frequency inverter is addressed via the **control word** of the Statemachine. The possible states and transitions are shown in the diagram.

The states and transitions are marked by squares and arrows, respectively. The numbers at the arrows identify the transitions between the states. The codes 0xnn at the transitions are the corresponding control word required (bit 0...7). The codes 0xnn indicated in the states, indicate the content of the status word (bit 0 ... bit 7).

Sequence in Statemachine:

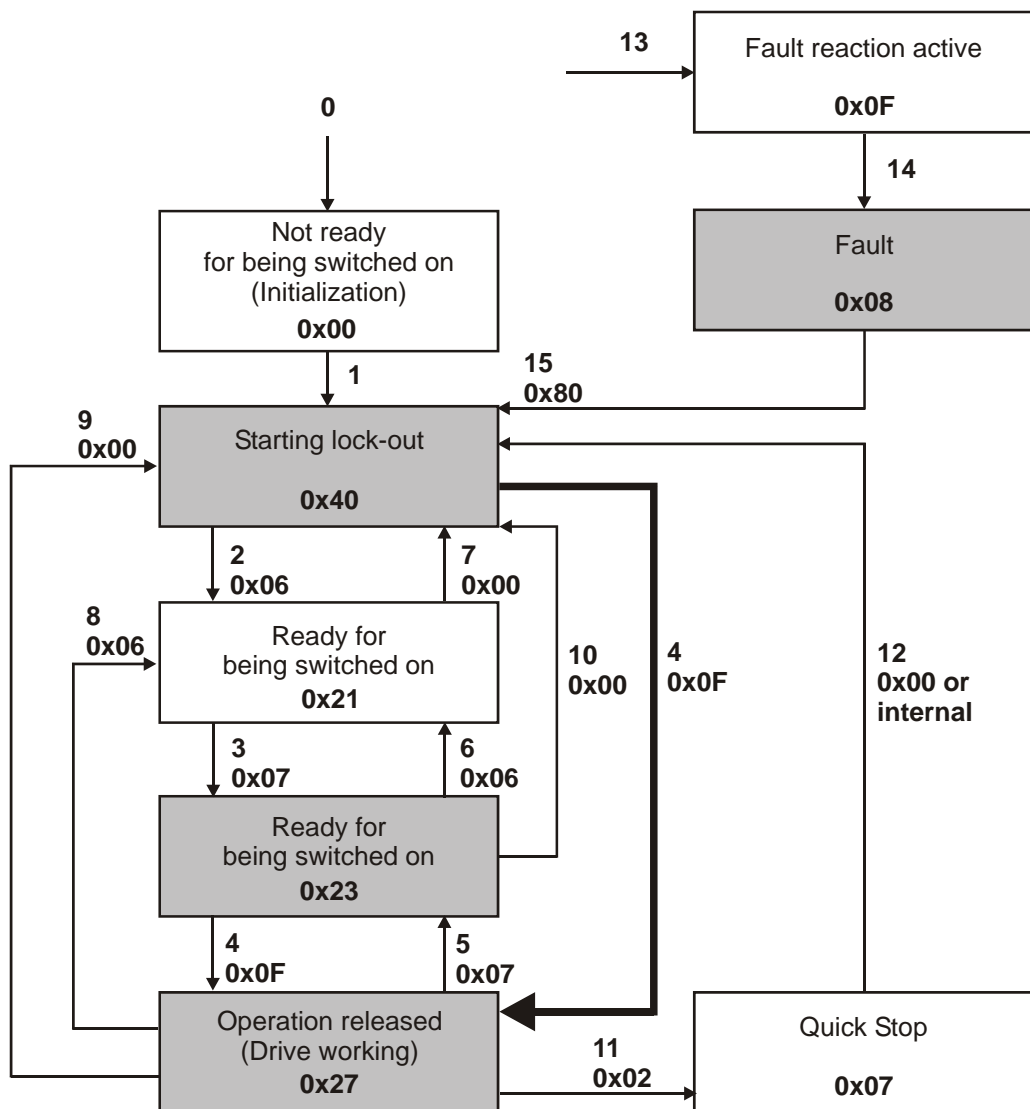

After mains on (Reset), the inverter is in the state "Starting lock-out" (0x40). With transitions 4 and 5, there is a change between "Operation released" (0x27, output stages released, drive working) and "Switched on" (0x23, output stages disabled).

The release (transition 4) is only possible if the controller release signal and the corresponding control command are present at digital inputs external release AND (S2IND OR S3IND). They can be firmly wired or also firmly linked to the logic states On or Off via the configuration of the digital inputs. If the control signal at the external release is withdrawn, the output stages can be disabled at any time. The drive then coasts to a standstill. In this case, there is a transition to "Switched on" (0x23, output stages disabled).

The behaviour of **Transition 5** can be set via parameter *state-transition 5* **392**. Here, you can use coasting, shut-off via ramp (reversible) or DC braking (depending on the selected configuration, see Chapter 9.1.2.2, " Behavior in state-transition 5").

Parameter *Control Word* **410** has a length of 16 bits. The set bits have the following meaning:

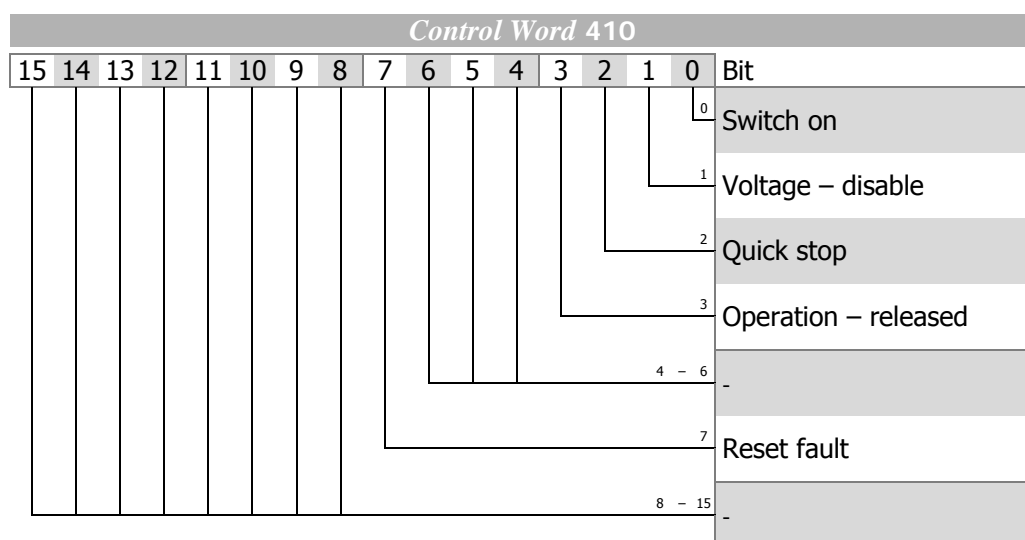

Control Commands

The device control commands are triggered by the following bit combinations in parameter *Control Word 410*:

Control Commands							
Command	Control word						Transition
	HEX	Bit 7	Bit 3	Bit 2	Bit 1	Bit 0	
Shutdown	0x06	X ¹⁾	X	1	1	0	2, 6, 8
Switch on	0x07	X	X	1	1	1	3
Voltage - disable	0x00	X	X	X	0	X	7, 9, 10
Quick stop	0x02	X	X	0	1	X	11
Operation – disable	0x07	X	0	1	1	1	5
Operation – released	0x0F	X	1	1	1	1	4
Reset fault	0x80	0 ⇒ 1	X	X	X	X	15

¹⁾ "X" means any value ("0" or "1")

In order to facilitate the operation of the device, an additional feature was implemented in the extension to the state machine defined under DRIVECOM. There is an additional transition 4 (0x0F) from "Starting lock-out" (0x040) to "Operation released" (0x27). Transition 4 is marked in the flow chart by a thick arrow.

The shaded areas show the commands relevant to the simplified Statemachine.

If a fault occurs, the "Fault" state is activated.

Note: If the command "Reset Fault" is executed, transition 15 takes place upon a positive edge of bit 7!
A fault can only be acknowledged 15 seconds after the occurrence of the fault, i.e. after the internal blocking time has elapsed.

The parameter *Status Word 411* has a length of 16 bits. The set bits have the following meaning:

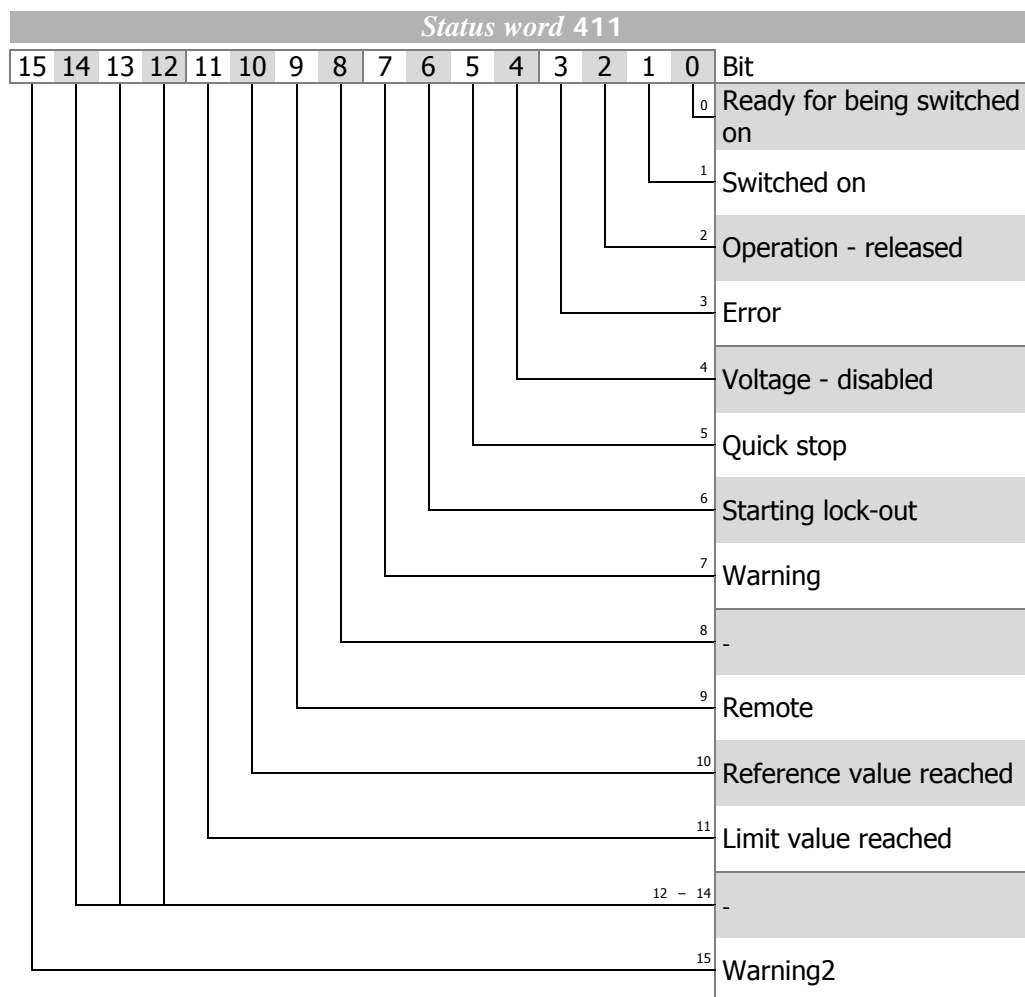

The status word reflects the operation state.

Status word	HEX ¹⁾	Bit 6	Bit 5	Bit 3	Bit 2	Bit 1	Bit 0
Not ready for being switched on	0x00	0	X ²⁾	0	0	0	0
Starting lock-out	0x40	1	X	0	0	0	0
Ready for being switched on	0x21	0	1	0	0	0	1
Quick stop	0x07	0	0	0	1	1	1
Switched on	0x23	0	1	0	0	1	1
Operation released	0x27	0	1	0	1	1	1
Error	0x08	0	X	1	0	0	0
Fault reaction active	0x0F	0	X	1	1	1	1

¹⁾ without consideration of bits 7...15!

²⁾ "X" means any value ("0" or "1")

The shaded areas show the commands relevant to the simplified Statemachine.

Status Word Bit 7 to Bit 15

Bit 7, "Warning bit"

The **warning bit "7"** can come at any time. It signals an internal warning and results in the frequency inverter being switched off, depending on the cause.

The evaluation of the warning is done by reading out the warning status via parameter *Warnings* **270**.

Bit 9, "Remote"

The **remote bit** is set if the operation mode "Control via control word of Statemachine" (*Local/Remote* **412** = 1) is set and the controller release signal is present at the external release and the start command is present at digital input S2IND or S3IND.

Note: The frequency inverter can only be addressed via the control word if the hardware release is set and the remote bit *Local/Remote* **412** = 1 is set.

Bit 10, "Reference value reached"

The bit "**Reference value reached**" is set when the specified reference value is reached. In the special case of power failure regulation, the bit is also set when the power failure regulation reaches the frequency 0 Hz (see frequency inverter operating instructions).

For "Reference value reached" there is a hysteresis (tolerance range) which can be set via the parameter *Max. Control Deviation* **549** (see frequency inverter operating instructions).

Bit 11 "Limit active"

The bit **Limit value active** indicates that an internal limit is active. This may be the current limit, the torque limit or the overvoltage control. All functions result in the reference value being left or not reached.

Bit 15 "Warning2"

The bit "**Warning2**" extends bit 7 "Warning bit" by the following information:

Bit 15 signals a critical operating state which will result in a fault switch-off of the frequency inverter within a short time. This bit is set if there is a delayed warning relating to the motor temperature, heat sink/inside temperature, Ixt monitoring or mains phase failure.

If **bit 15** is set, **bit 7** is set, too.

9.1.2.1 Behavior in Case of Quick Stop

In this case, the parameters *Switch-Off Threshold 637* (percentage of parameter *Maximum Frequency 419*) and *Holding Time 638* (holding time after the value drops below the switch-off limit) are relevant.

In a quick stop, the drive is brought to a standstill via the emergency stop ramps (*Emergency Stop Clockwise 424* or *Emergency Stop Anticlockwise 425*).

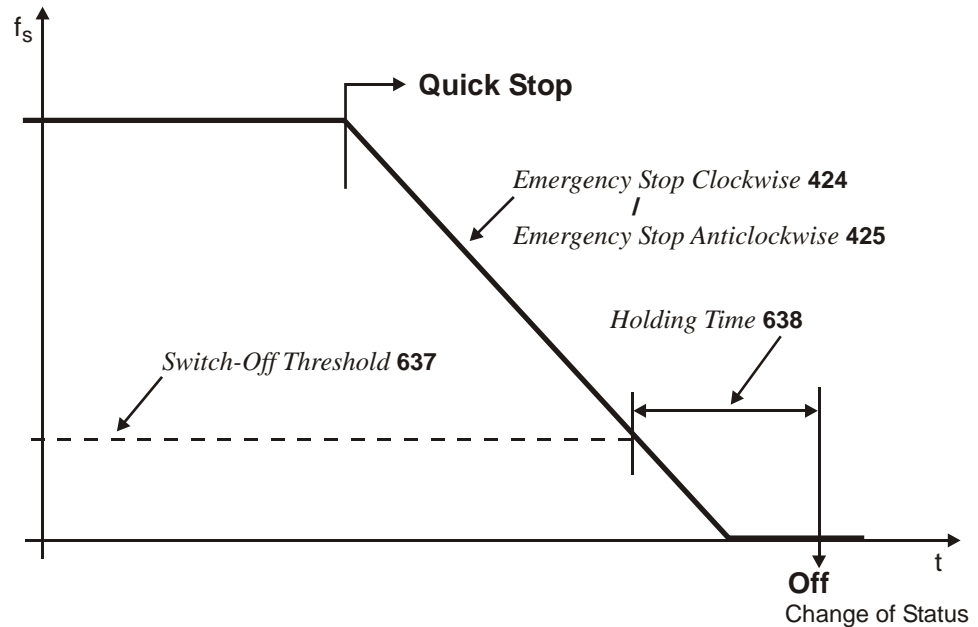

If frequency/speed reaches the value zero during the switch-off time, the drive continues to be supplied with current until the switch-off time has elapsed. This ensures that the drive is at a standstill when the state changes.

9.1.2.2 Behavior in state-transition 5 (from "Operation released" to "Switched on")

The behavior in transition 5 (from "Operation released" to "Switched on") can be parameterized via parameter *state-transition 5 392*.

<i>state-transition 5</i>		function
0 –	Coast to Stop	Immediate transition from "Operation released" to "Switched on", drive coasts to a standstill
1 –	DC-Brake	Activation of DC brake, at the end of DC deceleration, there is the change from "Operation released" to "Switched on"
2 –	Ramp	Transition at normal ramp, when the drive has come to a standstill, there is the change from "Operation released" to "Switched on"

Note: Setting 1 "DC-Brake" is only possible with applications with sensorless control (e.g. configuration 110). Other configurations do not support this operation mode.
If the frequency inverter is operated with a configuration which does not support the operation mode DC-Brake (e.g. configuration 210, field-oriented control), value "1" cannot be used.
In this case, the operation mode is not offered in the selection menus of the control unit KP500 and the control software VPlus.

The default value for *state-transition 5 392* is operation mode 2 (ramp). For configurations with torque control, the default value is 0 (coasting).

If the configuration is changed, the value set for *state-transition 5 392* is also changed, if necessary.

Note: If *state-transition 5 392* was triggered with value 1 "Direct current brake", a new control word will only be accepted after the transition process is complete. The change of state from "Operation released" to "Switched on" is done after the *Braking Time 632* parameterized for the DC brake has elapsed.

If parameter *state-transition 5 392* = 2 "ramp" is set, the control word can be set to 0x0F again, while the drive is decelerating. In this way, the drive accelerates to its set reference value again and remains in the state "Operation released".

The change of state from "Operation released" to "Switched on" is done after the value has dropped below the set switch-off threshold **and** the set holding time has elapsed (equivalent to the behavior in the case of a quick stop). In this case, the parameters *Switch-Off Threshold 637* (percentage of parameter *Maximum Frequency 419*) and *Holding Time stop function 638* (holding time after the value drops below the switch-off limit) are relevant.

9.1.3 Control via Remote Contacts

In the operation mode Control via remote contacts (*Local/Remote* 412 = 2), the frequency inverter is addressed via parameter *Control Word* 410.

The digital inputs S1IND ... S6IND and the multifunction input MFI1D of the frequency inverter as well as inputs EM-S1IND ... EM-S3IND of the optional expansion modules are emulated through Bit 0 ... Bit 9 of parameter *Control Word* 410.

If the remote contacts are used, the inverter behaves in the same way as in the case of addressing via the digital inputs. For the function and the parameterization of these inputs, refer to the frequency inverter operating instructions.

- Note:** A release is possible only if
- bit 0 of the control word is set to "1" **and**
 - the external via hardware is set to "1"

Controller release via the software alone is not possible.

Sequence in Statemachine:

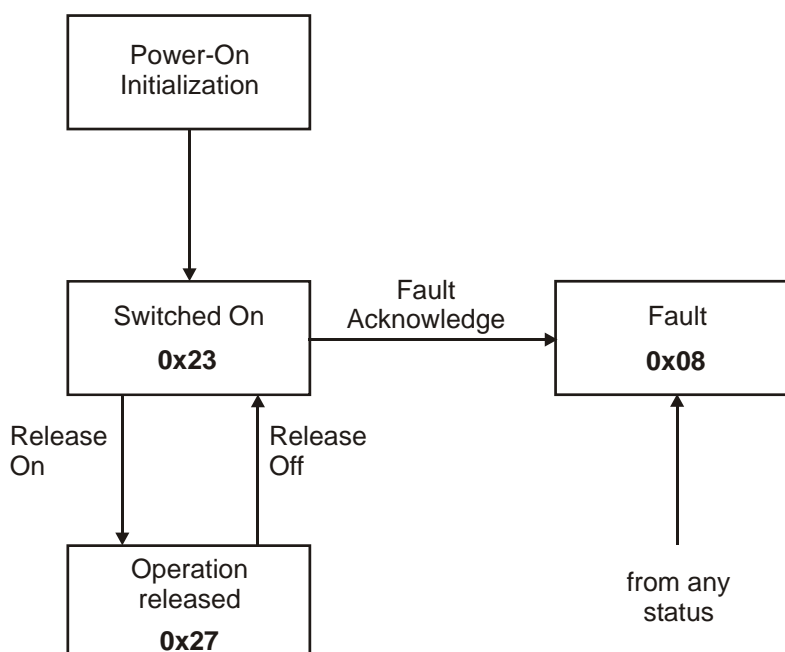

The numbers indicated in the individual operating statuses (e.g. 0x23) signal the corresponding feedback via the status word (bit 0...6).

Note: Inputs which are set via the control word can be monitored via the control unit KP500 or the control software VPlus by means of parameter *Digital Inputs* 250.

Digital inputs are indicated as set only if the controller release signal is present **and** if bit 0 in the control word is set to "1".

Note: If data set change-over is used, make sure that the parameter *Local/Remote* 412 is set to "2" (control via remote contacts) in all assigned data sets.

Note: With the use of remote contacts the signal sources* are taken over from the control word 410. Signals at the hardware contacts (terminals) are not evaluated by the standard operation modes (e.g. 71 for S2IND). For the evaluation of terminal signals special operation modes are available. They are denoted with the additional term "(Hardware)" and numbered from 526 to 546.

Exception: The controller release via the hardware contact S1IND (terminal X210A.3) and Bit 0 "S1IND" of the *controlword* must be set.

It is not possible to release the controller only via software.

Signal sources are:

- S1IND ... S6IND,
- MF11D,
- EM-S1IND ... EM-S3IND

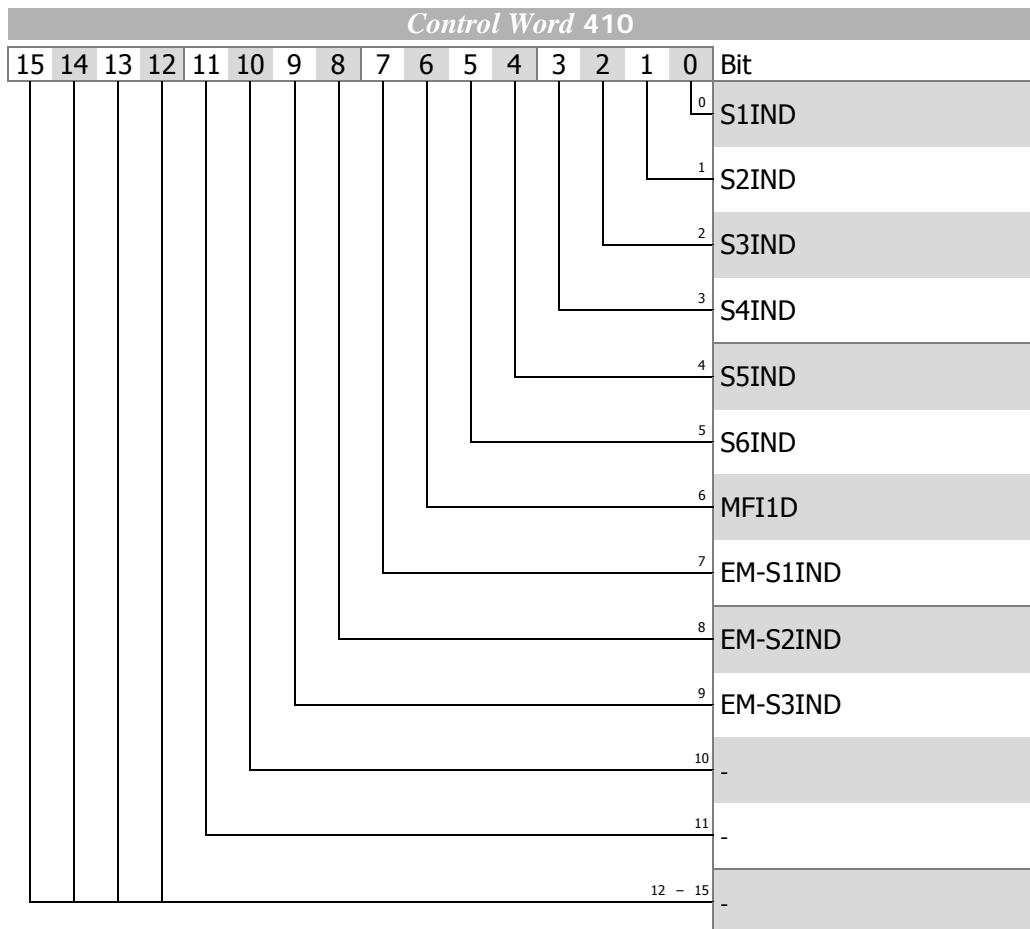

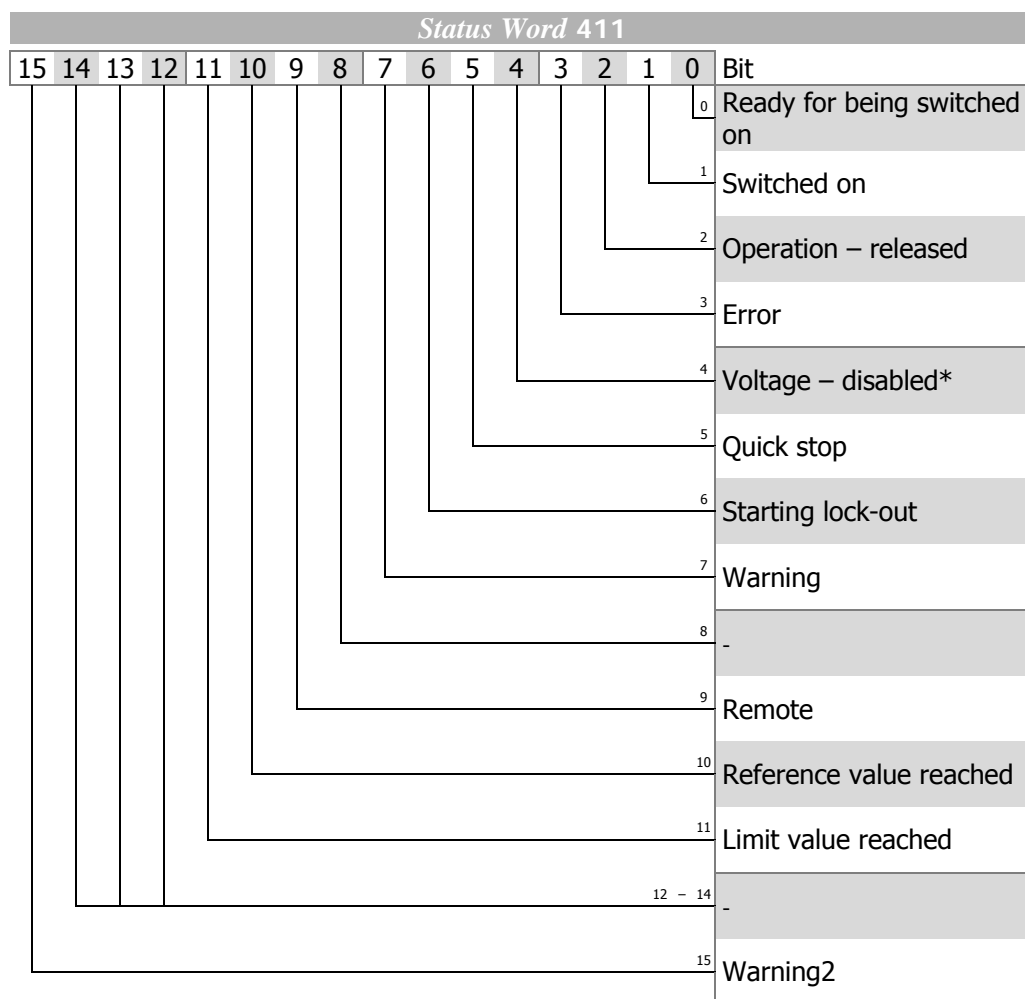

* The logic state is "0" for ACT devices.

The status word reflects the operation state.

Status word	HEX ¹⁾	Bit 6	Bit 5	Bit 3	Bit 2	Bit 1	Bit 0
Switched on	0x23	0	1	0	0	1	1
Operation released	0x27	0	1	0	1	1	1
Error	0x08	0	X ²⁾	1	0	0	0

¹⁾ without consideration of bits 7...15!

²⁾ "X" means any value ("0" or "1")

If a fault occurs, the fault status is activated.

Note: A fault can only be acknowledged 15 seconds after the occurrence of the fault, i.e. after the internal blocking time has elapsed.

If a fault has occurred, the cause of the fault can be read out via parameter *Current Error 260*.

Status Word Bit 7 to Bit 15

Bit 7, "Warning bit"

The **warning bit "7"** can signal an internal warning and results in the frequency inverter being switched off, depending on the cause.

The evaluation of the warning is done by reading out the warning status via parameter *Warnings* **270**.

Bit 9, "Remote"

The "**Remotebit**" is set if the "Operation mode Control via remote contacts" is set (*Local/Remote* **412** = 2) **and** the external controller release signal is present. Only then can the frequency inverter be controlled via the control word.

Bit 10, "Reference value reached"

The bit "**Reference value reached**" is set when the specified reference value is reached. In the special case of power failure regulation, the bit is also set when the power failure regulation reaches the frequency 0 Hz (see frequency inverter operating instructions).

For "Reference value reached" there is a hysteresis (tolerance range) which can be set via the parameter *Max. Control Deviation* **549** (see frequency inverter operating instructions).

Bit 11 "Limit active"

The bit **Limit value active** indicates that an internal limit is active. This may be the current limit, the torque limit or the overvoltage control. All functions result in the reference value being left or not reached.

Bit 15 "Warning2"

The bit "**Warning2**" extends bit 7 "Warning bit" by the following information:

Bit 15 signals a critical operating state which will result in a fault switch-off of the frequency inverter within a short time. This bit is set if there is a delayed warning relating to the motor temperature, heat sink/inside temperature, Ixt monitoring or mains phase failure.

If **bit 15** is set, **bit 7** is set, too.

9.2 Reference Value

9.2.1 Reference Frequency

The following signal sources are available for determining the reference frequency:

- External reference value as reference line value from bus
- Internal reference value from the reference frequency channel

The reference line value with the parameter name *Reference Frequency RAM 484* is sent to the frequency inverter via the bus.

The internal reference value reaches the frequency inverter via the reference frequency channel. The reference frequency channel is configured via parameter *Reference Frequency Source 475*.

The actual value can be read back via different parameters. The selection depends on the control method used and the application. The following parameters are possible, for example:

- *Stator Frequency 210* (data type long, Hz)
- *Encoder 1 Frequency 217* (Speed Sensor 1 Frequency) (data type long, Hz)
- *Encoder 1 Speed 218* (Speed Sensor 1 Speed) (data type int, rpm).

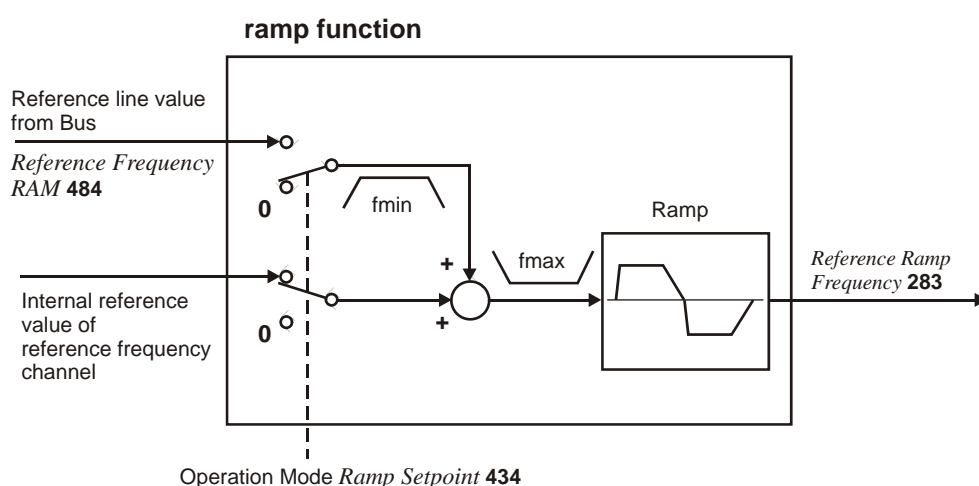

The internal reference value from the reference frequency channel and the reference line value (line setpoint) can be fed to the ramp individually or as an added variable. The result is available at the output of the ramp function as *Reference Ramp Frequency 283*.

The operation mode of the ramp function is set via the data set related parameter *Ramp Setpoint 434*.

For information on the reference frequency channel, refer to the frequency inverter operating instructions.

<i>Ramp Setpoint 434</i>		Function
1 –	Internal Setpoint	The internal reference frequency is determined from the reference frequency channel.
2 –	Line Setpoint	The reference value is supplied externally via the bus
3 –	Internal + Line Setpoint	Addition (considering the sign) of internal reference frequency and reference line value

For *Ramp Setpoint 434* = 3, the sign of the overall reference value is obtained from the addition of the reference frequency + the reference line value.

Note: If *Ramp Setpoint 434* = 2 (reference line value only), this reference line value is limited to *fmin*.
 In this case, consider that the sign in front of *fmin* with reference value = 0 is derived from the sign in front of the last reference line value which was not 0.
 After Mains On, the reference line value is limited to +*fmin* (motor clockwise).

The reference values can be controlled at the frequency inverter via the control unit KP500 or the control software VPlus via the following parameters:

- *Internal Reference Frequency 228* = internal ref. value from ref. freq. channel
- *Reference Bus Frequency 282* = reference line value from serial interface
- *Reference Ramp Frequency 283* = sum of internal reference frequency + reference line value

For information on the reference frequency channel, refer to the frequency inverter operating instructions.

9.2.2 Reference Percentage

The following signal sources are available for determining the reference percentage:

- External reference value as reference line value from bus
- Internal reference value from the reference percentage channel

The reference line value with the parameter name *Reference Percentage RAM 524* is sent to the frequency inverter via the bus.

The internal reference value reaches the frequency inverter via the reference percentage channel. The reference percentage channel is configured via parameter *Reference Percentage Source 476*.

The parameter *Reference Percentage Value 229* can be read back as an actual value.

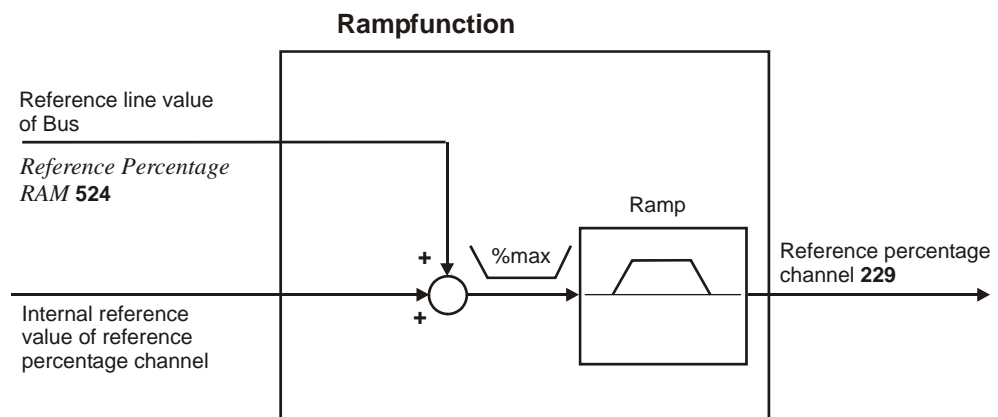

The internal reference value from the reference percentage channel and the reference line value are fed to the ramp as an added variable. The sum of the two variables has a positive or a negative sign according to the mathematical operation.

For information on the reference percentage channel, refer to the frequency inverter operating instructions.

- Note:**
- The actual value parameter *Reference percentage 229* can be checked at the frequency inverter via the control unit KP500 or the control software VPlus.
 - For example, the *Reference Percentage Value 229* is processed in the frequency inverter via the functions "Technology Controller" or "Torque Controller" (e.g. speed controller for torque limitation. For more information refer to the frequency inverter operating instructions.

10 ACU Inverter Control/Reference Value

The frequency inverter can be controlled completely via the serial interface. The following parameters and actual values are used for this:

Parameter		Settings			
No.	Name/Meaning	min.	max.	fact. sett.	type
410	Control Word	0x0000	0xFFFF	–	uInt
411	Status Word	0x0000	0xFFFF	–	uInt
484	Reference Frequency RAM [Hz]	-999.99	999.99	0.00	Long
524	Reference Percentage RAM [%]	-300.00	300.00	0.00	Long

With the *Control Word 410* (data type uInt), control commands are sent to the frequency inverter, with the *Reference Frequency RAM 484* (data type Long [Hz]) or *Reference Percentage RAM 524* (data type Long [%]), the reference line value is sent. Via the *Status Word 411* (data type uInt), the status of the frequency inverter is read out.

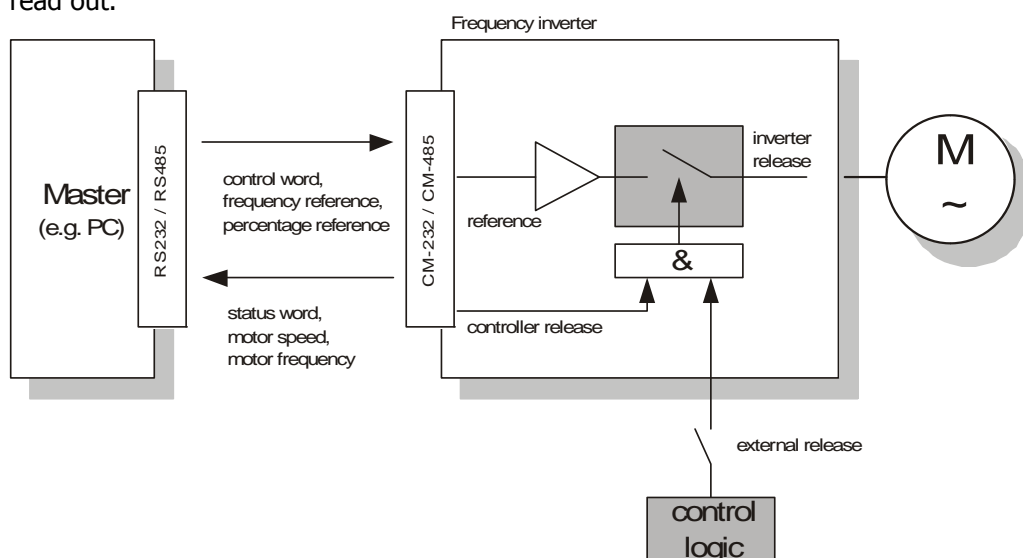

Note: *Control Word 410, Reference Frequency RAM 484 and Reference Percentage RAM 524* are stored in the RAM of the frequency inverter. This is generally addressed via data set 0.

Note: External release:

- The ACU inverter inputs STOA (S1IND) and STOB (S7IND) must be enabled.
- These digital inputs have the highest priority and have to be hard-wired.

The control of the frequency inverter can be done in principle with three operation modes. They are set via the data set change-over capable parameter *Local/Remote 412*.

Parameter		Setting		
No.	Description	Min.	Max.	Fact. sett.
412	Local/Remote	0	44	44

For operation, only the settings 0, 1 and 2 are relevant. The further settings relate to the possibilities of control via the KP500 control unit.

Control mode	Function
0 - Control via digital inputs	The Start and Stop command as well as the statement of the direction of rotation are via digital input signals.
1 - Control via state machine	The inverter is controlled by the <i>controlword</i> . Only in this control mode the motion control functions are supported by controlword and modes of operation.
2 - Control via remote digital inputs	The Start and Stop command as well as the statement of the direction of rotation are via digital input signals emulated by the bits of the <i>controlword</i> .

Note: The parameter *Local/Remote 412* is data set change-over capable. Thus, switching over between various control modes via the data set selection is possible.

The data set change-over can be done locally at the frequency inverter via digital inputs or via the bus. For the data set change-over via the bus, the parameter *Data set selection 414* is used.

Parameter		Setting		
No.	Description	Min.	Max.	Fact. sett.
414	Data set selection	0	4	0

With *Data set selection 414* = 0, the data set switch-over via digital inputs is active. If *Data set selection 414* has been set to 1, 2, 3, or 4, the data set selected in this way has been activated. The data set switch-over via the digital inputs is then disabled.

Via the parameter *Active data set 249* the data set currently selected can be read out. *Active data set 249* states the activated data set with the value 1, 2, 3 or 4. This is independent of whether the data set change-over has been done via digital inputs or via *Data set selection 414*.

10.1 Control via contacts/remote contacts

In the operation mode control via digital inputs (parameter *Local/Remote* 412 = 0) or remote digital inputs (parameter *Local/Remote* 412 = 2) the frequency inverter is controlled via the digital inputs S1IND, S2IND to S6IND directly or by digital input emulation with help of the single bits in the *controlword*. The meaning of these inputs can be seen from the operating instructions.

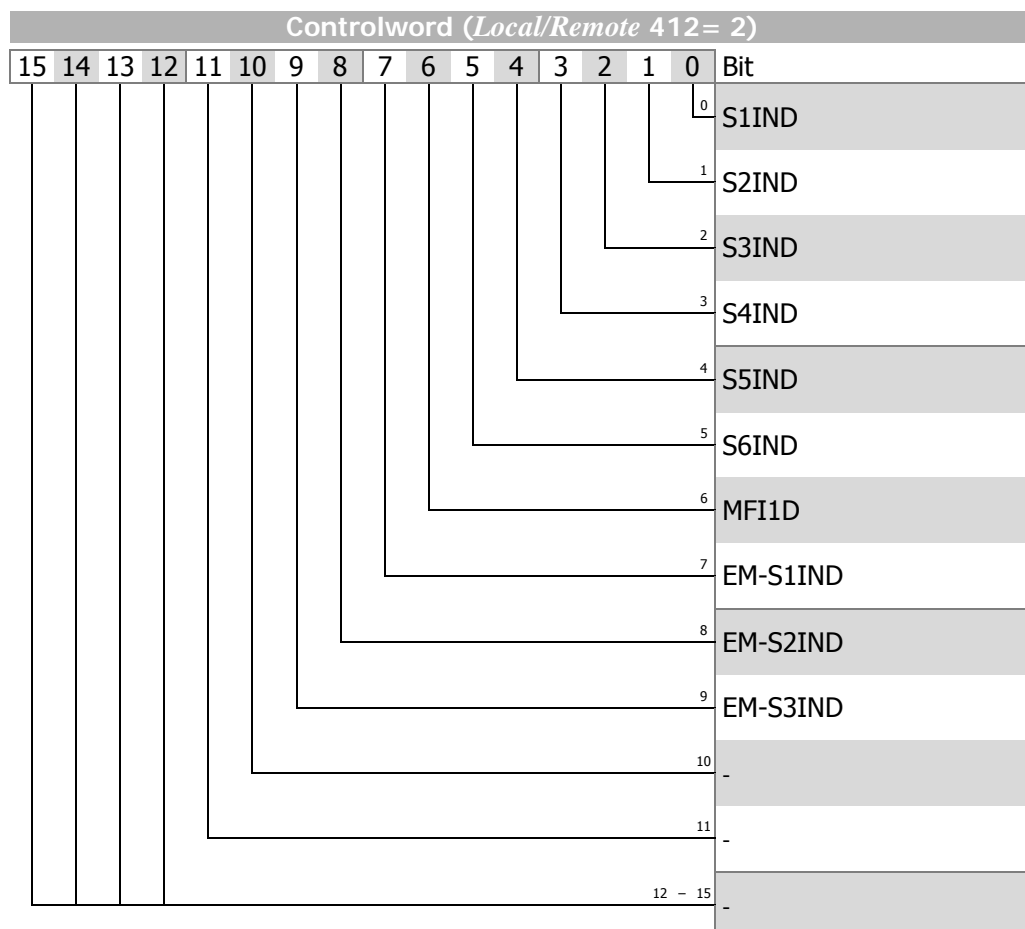

Note: When using the control mode "control via remote digital inputs" the controller release via STOA (terminal X210A.3) and STOB (terminal X210B.2) must be set AND bit 0 of *controlword* must be set to get the drive started.

The two control modes digital inputs and remote digital inputs facilitate the *mode of operation* "velocity mode" only.

Note: With the use of remote contacts the signal sources* are taken over from the control word 410. Signals at the hardware contacts (terminals) are not evaluated by the standard operation modes (e.g. 71 for S2IND). For the evaluation of terminal signals special operation modes are available. They are denoted with the additional term "(Hardware)" and numbered from 526 to 546. Exception: The controller release via the hardware contacts STOA (terminal X210A.3) and STOB (terminal X210B.2) must be set and Bit 0 "S1IND" of the *controlword* must be set. It is not possible to release the controller only via software.

Signal sources are:
 - S1IND ... S6IND,
 - MFI1D,
 - EM-S1IND ... EM-S3IND

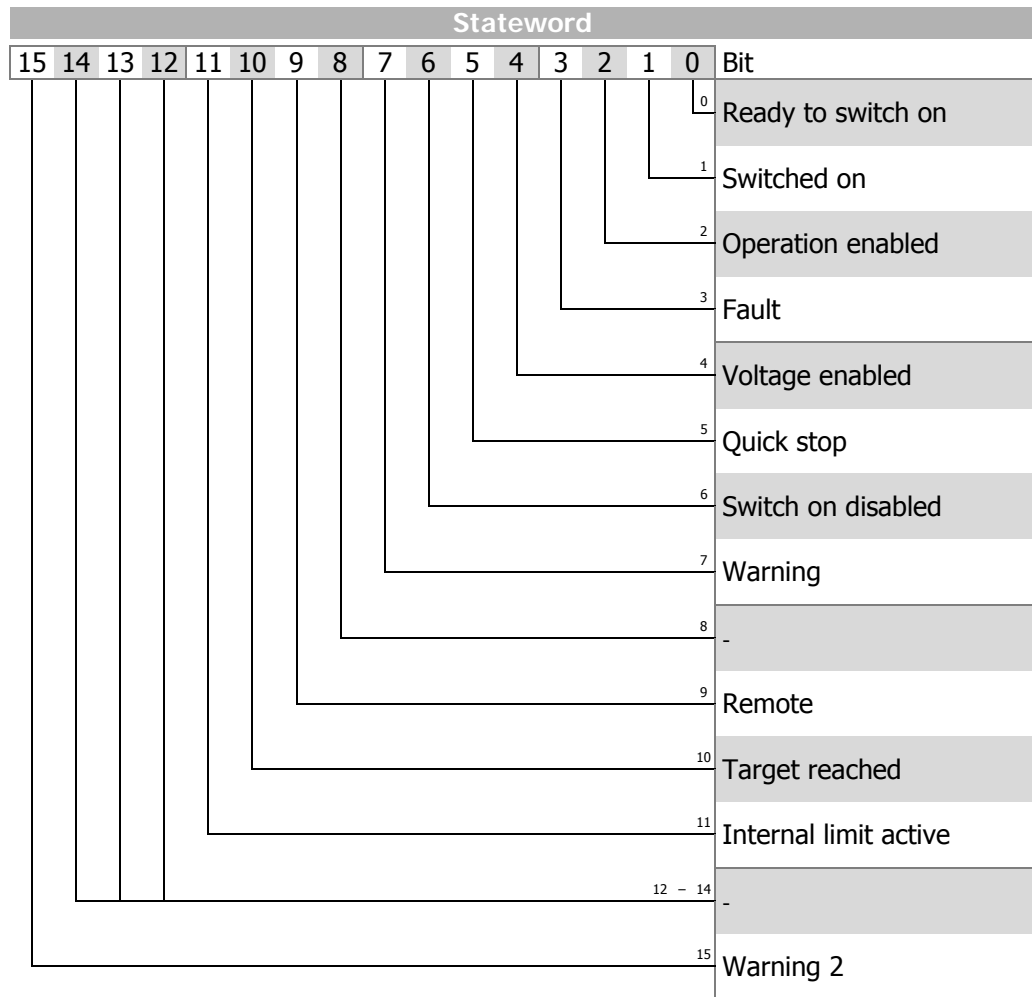

Note: ACTIVE CUBE inverters support an external 24V supply for control logic. Even if the mains are not switched on the communication between PLC and inverter can be established.

The bit 4 "Voltage enabled" of the *statusword* displays the current state of the mains power supply.

Bit 4 "Voltage enabled" = 0 signals "no mains voltage" and the drive start is disabled.

Bit 4 "Voltage enabled" = 1" signals "mains voltage switched on" and the drive is ready to start.

State machine:

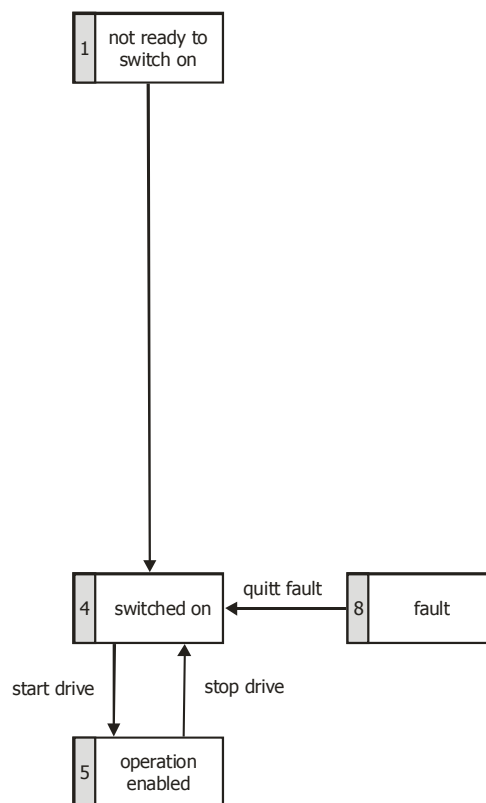

Stateword	Bit 5	Bit 4	Bit 3	Bit 2	Bit 1	Bit 0
Switched on	1	0	0	0	1	1
Operation enabled	1	1	0	1	1	1
Fault	x	x	1	x	x	x

Note: Bits marked "x" are don't care.

The **Warning bit "Bit No. 7"** can signal an internal warning and results in the frequency inverter being switched off, depending on the cause. The evaluation of the warning is done by reading out the warning status via parameter *Warnings 270*.

The bit **Target reached "Bit No. 10"** is set when the reference value specified has been reached. In the special case of power failure regulation, the bit is also set if the power failure regulation has reached the frequency 0 Hz (see operating instructions). For "Reference value reached" there is a hysteresis (tolerance range), which can be set via the parameter *max. Control deviation 549* (see operating instructions).

The bit **Internal limit active "Bit No. 11"** displays that an internal limit is active. This can, for example, be the present current limit, the torque limit or the over-voltage limit. All the functions lead to the reference value being quit or not reached.

The bit **Warning 2 "Bit No. 15"** reports a warning which leads to a fault switch-off of the frequency inverter within a short time. This bit is set if there is a warning for motor temperature, heat sink/inside temperature, Ixt monitoring or mains phase failure.

10.2 Control via state machine

In the operation mode "control via state machine" (parameter *Local/Remote* **412** = 1) the frequency inverter is controlled via *controlword*.

State transition 4 to state "Operation enabled" is only possible when:

Motion control configuration (*Configuration* **30** = **x40**):

→ controller release at STOA and STOB is set.

In other configurations (non motion control, *Configuration* **30** ≠ **x40**):

→ controller release at STOA and STOB is set AND (S2IND OR S3IND)
(S2IND = start clockwise/S3IND = start anticlockwise)

The behavior of transition 5 can be set via the parameter *State transition 5* **392**. Here, free stopping, shutdown via ramp (reversible) or DC braking (see Chapter "Behavior in transition 5") can be used.

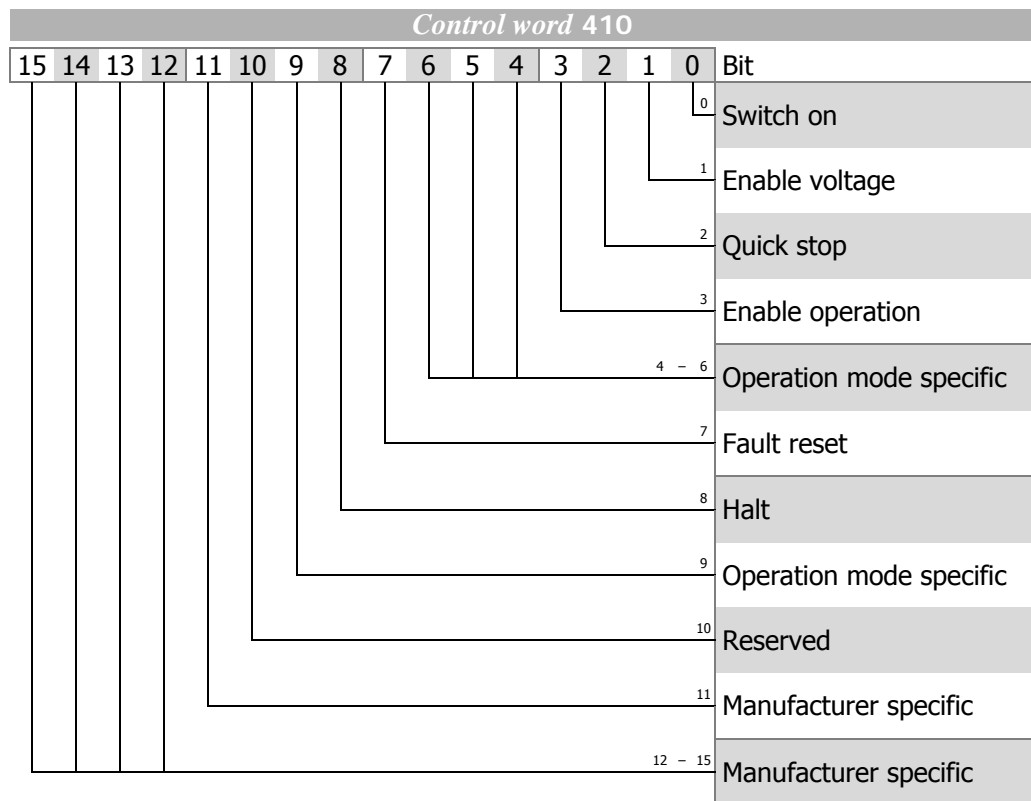

Bits 9 ... 15 unused

Controlword bits 4, 5, 6 *operation mode specific* and bit 8 *halt* are used in motion control configurations (*Configuration* **30** = **x40**) only.

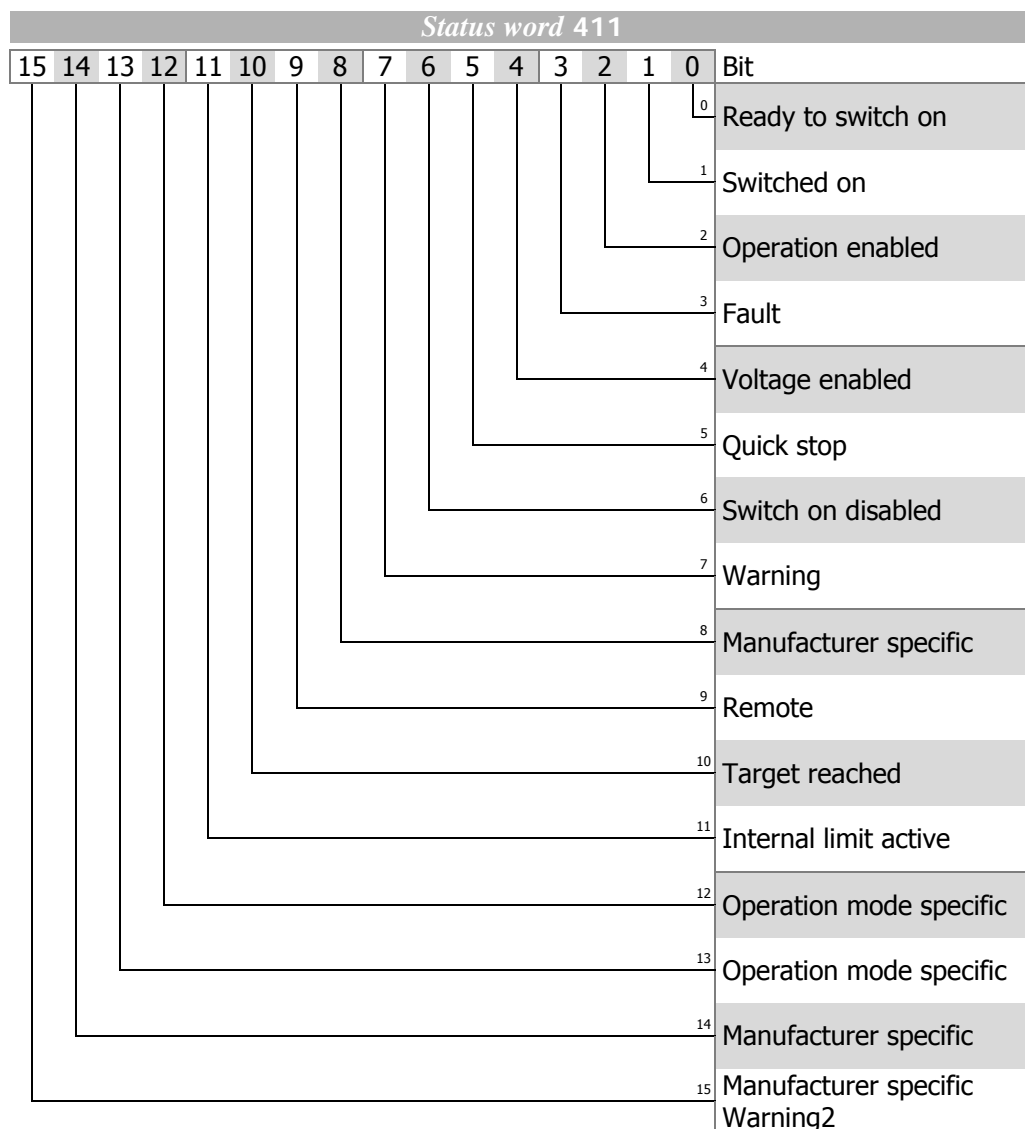

Bit 14 unused

Statusword bits 12 + 13 *operation mode specific* are used in motion control configurations (*Configuration 30 = x40*) only.

Note: ACTIVE CUBE inverters support an external 24V supply for control logic. Even if the mains are not switched on the communication between PLC and inverter can be established.

The bit 4 "Voltage enabled" of the *statusword* displays the current state of the mains power supply.

Bit 4 "Voltage enabled" = 0 signals "no mains voltage" and the state transition "Ready to switch on" → "Switched on" is not possible.

Bit 4 "Voltage enabled" = 1" signals "mains voltage switched on" and the state transition "Ready to switch on" → "Switched on" is possible.

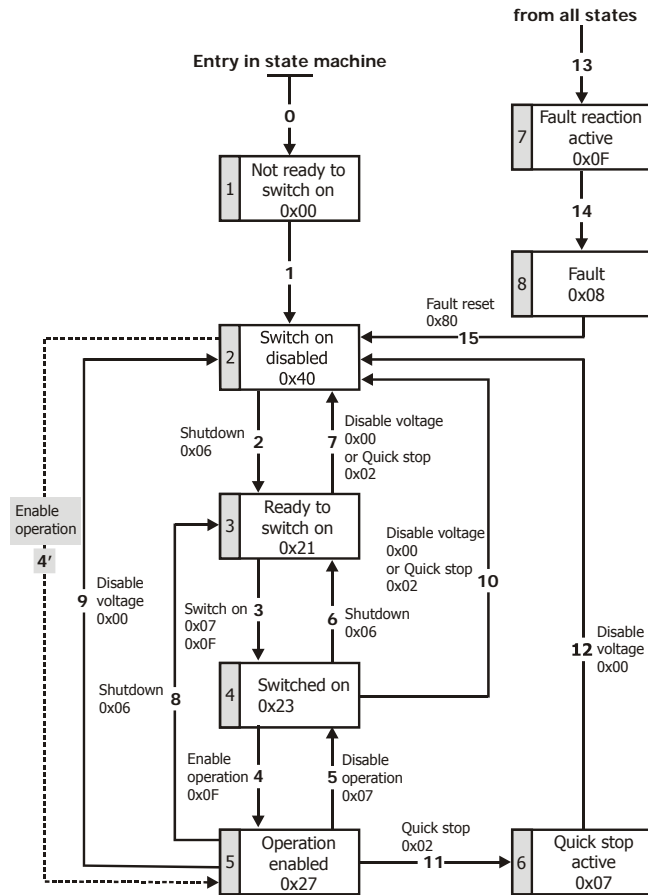
State machine:

The device control commands are triggered by the following bit pattern in the *control-word*:

Controlword						
Command	Bit 7	Bit 3	Bit 2	Bit 1	Bit 0	Transitions
	Fault reset	Enable operation	Quick stop	Enable voltage	Switch on	
Shutdown	X	X	1	1	0	2, 6, 8
Switch-on	X	0	1	1	1	3
Switch on	X	1	1	1	1	3
Disable voltage	X	X	X	0	X	7, 9, 10, 12
Quick stop	X	X	0	1	X	7, 10, 11
Disable operation	X	0	1	1	1	5
Enable operation	X	1	1	1	1	4
Fault reset	0 ⇒ 1	x	x	x	x	15

Bits marked X are irrelevant

Note: The state transition 3 (command "Switch on") is processed only if bit no. 4 "Voltage enabled" of the *statusword* is set.

The state transition 4' is only available for non motion control configurations (*Configuration 30* ≠ x40) and is processed only if bit no. 4 "Voltage enabled" of the *statusword* is set.

The *statusword* displays the operation state.

Statusword						
state	Bit 6	Bit 5	Bit 3	Bit 2	Bit 1	Bit 0
	Switch on disabled	Quick stop	Fault	Operation enabled	Switched on	Ready to switch on
Switch on disabled	1	X	0	0	0	0
Ready to switch on	0	1	0	0	0	1
Switched on	0	1	0	0	1	1
Operation enabled	0	1	0	1	1	1
Quick stop active	0	0	0	1	1	1
Fault reaction active	0	X	1	1	1	1
Fault	0	X	1	0	0	0

Bits marked X are irrelevant

The **Warning bit "Bit No. 7"** can be set at any time. It displays a device-internal warning message. The evaluation of the warning reason is done by reading out the warning status with the parameter *Warnings 270*.

The **Remote bit "Bit No. 9"** is set if the operation mode control via state machine (*Local/Remote 412 = 1*) has been set **and** the hardware release is available.

Logic linking of the digital control signals:

STOA **AND** STOB **AND** (Start clockwise **OR** Start anticlockwise)

Only if the logic linking is true the inverter can be controlled via the. The logic inputs for Start clockwise / Start anticlockwise can be connected directly to ON (p.68, p.69).

Note: For motion control configurations (*Configuration 30 = x40*) only the digital input S1IND must be set. Start clockwise and start anticlockwise have no function in motion control configurations.

The bit **Target reached reached "Bit No. 10"** is set when the reference value specified has been reached.

In non motion control configurations (*Configuration 30 ≠ x40*) target reached is related to the reference speed object 0x6042 *target velocity*. In the special case of power failure regulation, the bit is also set if the power failure regulation has reached the frequency 0 Hz (see operating instructions). For "Target reached" there is a hysteresis (tolerance range), which can be set via the parameter *max. Control deviation 549* (see operating instructions).

The bit **Internal limit active "Bit No. 11"** displays that an internal limit is active. This can, for example, be the present current limit, the torque limit or the over-voltage limit. All the functions lead to the reference value being quit or not reached.

The bit **Warning 2 "Bit No. 15"** reports a warning which leads to a fault switch-off of the frequency inverter within a short time. This bit is set if there is a warning for motor temperature, heat sink/inside temperature, Ixt monitoring or mains phase failure.

10.2.1 Behavior in quick stop

In this, the parameters *Switch-off threshold 637* (percent of f_{max}) and *Holding time 638* (holding time after falling short of the switch-off threshold) are relevant. In a quick stop, the drive is shutdown via the emergency stop ramps (*Emergency stop clockwise 424* or *Emergency stop anti-clockwise 425*).

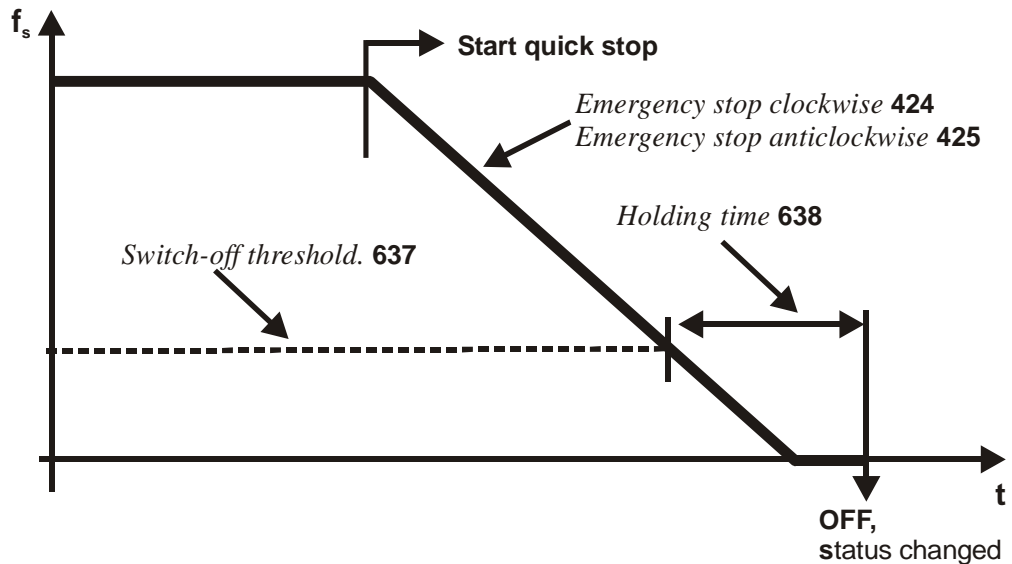

If frequency/speed zero has been reached during the holding time, the drive continues to be supplied with direct current until the switch-off time has expired. With this measure, there is an assurance that the drive is stationary in a change of state.

Note: The "behavior in quick stop" is only relevant for non motion control configurations (*Configuration 30* \neq *x40*).

10.2.2 Behavior in transition 5

The behavior in transition 5 from "Operation enabled" to "Switched on" can be parameterized. The behavior is set via parameter *State transition 5* **392**.

Parameter		Setting		
No.	Description	Min.	Max.	Fact. sett.
392	State transition 5	0	2	2

Operation mode	Function
0 - Coast to stop	immediate transition from "Operation enabled" to "Switched on", free stoppage of the drive
1 - DC brake	activation of DC brake, with the end of DC braking, there is the change from "Operation enabled" to "Switched on"
2 - Ramp	transmission with normal stop ramp, after reaching standstill, there is a change from "Operation enabled" to "Switched on"

Note: Setting operation mode 1 – "DC brake" is only possible in applications with v/f characteristic (e.g. configuration 110), as other applications do not know such an operation mode.

If the frequency inverter is operated with a configuration which does not know the DC braking operation mode (e.g. configuration 210, field-orientation speed controlled), value "1" cannot be set. It is also not offered in the selection menus of the KP500 control unit or the VPlus program.

Note: The default value for the parameter *State transition 5* **392** is operation mode "2 – Ramp". For configurations with torque control, the default value is operation mode "0 - Coast to stop". In a switch-over of the configuration, the setting value for *State transition 5* **392** is also altered if necessary.

Note: The "behavior in transition 5" is only relevant for non motion control configurations (*Configuration* **30** ≠ **x40**).

If transition 5 has been triggered with *State transition 5* **392** = "1 - DC brake", a new control word is only accepted after the completion of the transition process. The change of state from "Operation enabled" to "Ready" is done after the expiry of the time *Braking time* **632** parameterized for the DC brake.

If the parameter *State transition 5* **392** = "2 - Ramp" has been set, the *controlword* can be set back to "Enable operation" during the stoppage of the drive. In this way, the drive runs back up to its set reference value and remains in the state "Operation enabled".

The change of state from "Operation enabled" to "Switched on" is done after the set switch-off threshold has been reached **and** expiry of the set holding time (equivalent to the behavior in a quick stop). In this, the parameters *Switch-off threshold* **637** (percent of fmax) and *Holding time* **638** (holding time after switch-off threshold reached) are relevant.

10.2.3 Reference value/actual value

The control (PLC) can set the frequency reference value for the frequency inverter via the parameter *Reference Frequency RAM 484*.

The control (PLC) can set the percentage reference value for the frequency inverter via the parameter *Reference Percentage RAM 524*.

The value of the control will always be added to the local source value of *Reference Percentage Source 476*.

Note: The Parameters *Reference Frequency RAM 484* and *Reference Percentage RAM 524* can only be written. Read access is not possible.

The use of the reference/actual value channel depends on the set configuration (control system). The actual value is generated from the correct source depending on the control system used.

The actual value can be read out via parameter *Actual Frequency 241*. In addition, the internal reference frequencies can be read out.

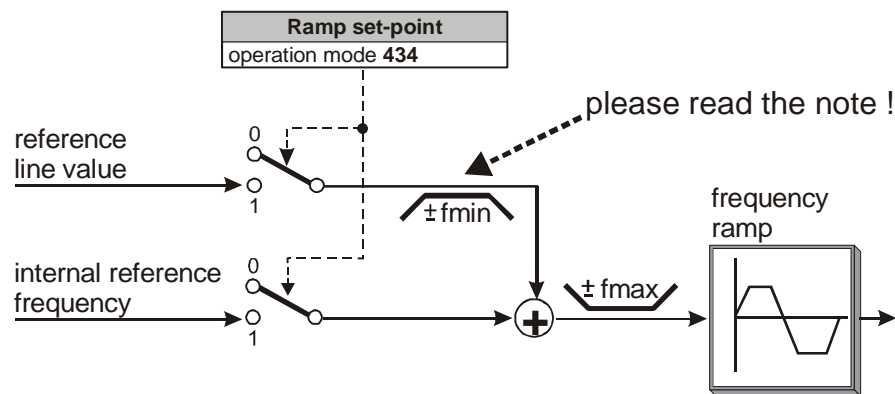

The internal reference value from the reference frequency value channel and the reference line value can be fed to the ramp individually or as an added variable. Setting is done via the data set change-over capable parameter *Ramp set-point 434*.

Parameter		Setting		
No.	Description	Min.	Max.	Fact. sett.
434	Ramp set-point	1	3	3

Operation mode	Function
0 - Internal setpoint (reference frequency value)	Reference value from the sources of the percentage of reference frequency value channel
1 - Line setpoint (reference line value)	Reference value via a communication interface
2 - Internal + line setpoint	Sum of internal reference frequency value and reference line value

Note: This function is only relevant for non motion control configurations (*Configuration 30 ≠ x40*).

Note: If *Ramp set-point 434* = 2 (only reference line value), this reference line value is limited to fmin. Please consider that the sign in front of fmin at reference value = 0 is derived from the sign in front of the last reference line value $\neq 0$.

After Power On, the reference line value is limited to +fmin!

For *Ramp set-point 434* = 3, the sign in front of the overall reference value results from the sum of internal reference frequency value and reference line value.

The reference values can be read out on the frequency inverter with the help of the KP500 control unit or VPlus operating software.

Actual values		
Parameter	Contents	Format
<i>Internal reference frequency</i> 228	Internal reference value from frequency reference value channel	xxx.xx Hz
<i>Reference bus frequency</i> 282	Reference line value from CANopen bus	xxx.xx Hz
<i>Reference ramp frequency</i> 283	Sum of internal + reference line value	xxx.xx Hz

11 Parameter List

The following tables contain parameters which are relevant to the CM-232 and CM-485 communication modules. For the other parameters, refer to the frequency inverter parameters.

For better clarity, the parameters have been marked with pictograms:

-  The parameter is available in the four data sets.
- The parameter value is set by the SETUP routine.
- This parameter cannot be written when the frequency inverter is in operation.
- This parameter is not accessible via the control unit KP500 and the control software VPlus; it is only accessible via the communication channel.







I_{FUN} , U_{FUN} , P_{FUN} : rated values of the frequency inverter, \hat{u} : overload capacity of frequency inverter

11.1 Actual Value Menu (VAL)

No.	Name/Meaning	Unit	Display range	Chapter	
Actual Values of the Frequency Inverter					
228	Internal Reference Frequency	Hz	-1000.00 ... 1000.00	9.2.1, 10.2.3	
229	Reference Percentage Value	%	± 300.00	9.2.2	
249	Active Data Set	–	1 ... 4	9	
250	Digital Inputs	–	0 ... 255	9.1.3	
<input checked="" type="checkbox"/>	260	Current Error	–	0 ... 0xFFFF	9.1; 12.2
<input checked="" type="checkbox"/>	270	Warnings	–	0 ... 0xFFFF (bit coded)	9.1; 12.1
282	Ref. Bus Frequency	Hz	-1000.00 ... 1000.00	9.2.1, 10.2.3	
283	Ref. Ramp Frequency	Hz	-1000.00 ... 1000.00	9.2.1, 10.2.3	
411	Status Word	–	0 ... 0xFFFF	9; 9.1	

11.2 Parameter Menu (PARA)

No.	Name/Meaning	Unit	Setting range	Chapter	
RS232/RS485					
10	Baud Rate	–	1 ... 6	5.2; 5.3	
Inverter Data					
<input checked="" type="checkbox"/>	11	Error state SSTVal	–	6.4	
<input checked="" type="checkbox"/>	34	Program(ming)	–	0 ... 9999	5.2; 5.3
Bus controller					
<input checked="" type="checkbox"/>	392	State-transition 5	–	0 ... 2	9.1.2.2, 10.2.2
RS232/RS485					
394	RS232/RS485 NodeID	–	1 ... 30	5.2;5.3	
395	Protocol	–	0 ... 1	5	
Bus controller					
410	Control Word	–	0 ... 0xFFFF	9; 9.1	
	412	Local/Remote	–	0 ... 44	9; 9.1, 10, 10.1

No.	Name/Meaning	Unit	Setting range	Chapter
RS232/RS485				
413	RS232/RS485 Watchdog Timer	s	0 ... 10000	6.5
Data Set Change-Over				
414	Data Set Selection	–	0 ... 4	9, 10
Frequency Ramps				
 424	Emergency Stop Clockwise	Hz/s	0,01 ... 9999.99	9.1.2.1, 10.2.1
 425	Emergency Stop Anticlockwise	Hz/s	0,01 ... 9999.99	9.1.2.1, 10.2.1
 434	Ramp Setpoint	–	1 ... 3	9.2.1, 10.2.3
Fixed Frequencies				
<input checked="" type="checkbox"/> 484	Reference Frequency RAM	Hz	-999.99 ... 999.99	9.2.1
Fixed Percentages				
<input checked="" type="checkbox"/> 524	Reference Percentage RAM	%	± 300.00	9.2.2
Digital Outputs				
549	Max. Control Deviation	%	0.01 ... 20.00	9.1
Direct current brake				
 632	Braking Time	s	0.0 ... 200.0	9.1.2.1;9.1.2.2
Stopping Behavior				
 637	Switch-Off Threshold	%	0.0 ... 100.0	9.1.2.1;9.1.2.2, 10.2.1
 638	Holding Time	s	0.0 ... 200.0	9.1.2.1;9.1.2.2, 10.2.1
System bus				
900	Node-ID		0 ... 63	6.3.3

12 Annex

12.1 Warning Messages

The various control functions and methods and the hardware of the frequency inverter contain functions that continuously monitor the application. In addition to the messages documented in the manual, the following warning messages are activated by the RS232/RS485 communication modules CM-232/CM-485.

The bit-coded warning reports are issued via parameter *Warnings* **270** according to the following pattern:

Warning Messages			
Bit no.	Warning code	Description	
0	0x0001	Warning Ixt	1) 2)
1	0x0002	Warning Short-Term Ixt	1)
2	0x0004	Warning Long-Term Ixt	2)
3	0x0008	Warning Heat Sink Temperature Tk	
4	0x0010	Warning Inside Temperature Ti	
5	0x0020	Warning I-limit	
6	0x0040	Warning Init	
7	0x0080	Warning Motor Temperature	
8	0x0100	Warning Phase Failure	
9	0x0200	Warning Motor Protection Switch	
10	0x0400	Warning Fmax	
11	0x0800	Warning Analog Input MFI1A	
12	0x1000	Warning Analog Input A2 (EM-S1INA)	
13	0x2000	Warning System Bus Slave Failure	
14	0x4000	Warning Udc	
15	0x8000	Warning V-belt	

- 1) 2) Bit 0 "Warning Ixt" is always set
- if bit 1 "Warning Short-Term Ixt" or
 - if bit 2 "Warning Long-Term Ixt" is set.

Note: The individual warnings are described in detail in the frequency inverter operating instructions.

Note: In parameter *Warnings* **270** several warnings can be displayed at the same time.

Example:

Message	Warning code	Remarks
Warning Ixt	0x0001	Is set in Short-Term Ixt or Long-Term Ixt
Short-Term Ixt	0x0002	
Warning Limit Heat Sink Temperature	0x0008	
Warning Motor Temperature	0x0080	
Total	0x008B	

12.2 Error Messages

Fault messages can be read out via parameter *Current Error 260*. The error code stored following a fault comprises the error group FXX (high-byte, hexadecimal) and the code YY (low-byte, hexadecimal).

General Fault Message		
Code		Meaning
F00	00	No fault has occurred.

Overload		
Code		Meaning
F01	00	Frequency inverter overloaded.
	02	Frequency inverter overloaded (60 sec), check load behavior.
	03	Short-term overload (1 sec), check motor and application parameters.

Heat Sink		
Code		Meaning
F02	00	Heat sink temperature too high, check cooling and fan.
	01	Temperature sensor defective or ambient temperature too low.

Inside		
Code		Meaning
F03	00	Inside temperature too high, check cooling and fan.
	01	Inside temperature too low, check electrical cabinet heating.

Motor Connection		
Code		Meaning
F04	00	Motor temperature too high or sensor defective, check connection S6IND.
	01	Motor circuit breaker tripped, check drive.
	02	The V-belt monitoring reports no load on the drive.
	03	Phase failure, check motor and wiring.

Output Current		
Code		Meaning
F05	00	Overloaded, check load situation and ramps.
	03	Short circuit or earth fault, check motor and wiring.
	04	Overloaded, check load situation and current value limit controller.
	05	Asymmetric motor current, check current and wiring.
	06	Motor phase current too high, check motor and wiring.
	07	Message from phase monitoring, check motor and wiring.

DC link voltage

Code		Meaning
F07	00	DC link voltage too high, check deceleration ramps and connected brake Resistor.
	01	DC link voltage too low, check mains voltage.
	02	Power failure, check mains voltage and circuit.
	03	Phase failure, check mains fuses and circuit.
	04	<i>Reference DC-Link Limitation 680</i> too low, check mains voltage.
	05	Brake chopper <i>Trigger Threshold 506</i> too low, check mains voltage.
	06	Motor chopper <i>Trigger Threshold 507</i> too low, check mains voltage.

Electronics voltage

Code		Meaning
F08	01	Electronics voltage 24 V too low, check control terminal.
	04	Electronics voltage too high, check wiring of control terminals.

Output frequency

Code		Meaning
F11	00	Output frequency too high, check control signals and settings.
	01	Max. frequency reached by control, check deceleration ramps and connected brake resistor.

Motor Connection

Code		Meaning
F13	00	Earth fault on output, check motor and wiring.
	01	Set <i>IDC Compensation Limit 415</i> reached, check motor and cabling, increase limit, if necessary.
	10	Minimum current monitoring, check motor and wiring.

Control Connection

Code		Meaning
F14	01	Reference value on multifunctional input 1 faulty, check signal.
	07	Overcurrent on multifunctional input 1, check signal.
	30	Speed sensor signal defective, check connections S4IND and S5IND.
	31	One track of the speed sensor signal is missing, check connections.
	32	Direction of rotation of speed sensor wrong, check connections.

Communication

Code		Meaning
F20	10	Communication watchdog RS232/RS485.

Note: In addition to fault messages mentioned, there are further fault messages. However these messages are only used for internal purposes and are not listed here. If you receive fault messages which are not listed here, please contact us !

12.3 ASCII Tabelle (0x00 – 0x7F)

Dec.	Hex.	Char.	Dec.	Hex.	Char.	Dec.	Hex.	Char.
0	00	NUL	43	2B	+	86	56	V
1	01		44	2C	,	87	57	W
2	02	STX	45	2D	-	88	58	X
3	03	ETX	46	2E	.	89	59	Y
4	04	EOT	47	2F	/	90	5A	Z
5	05	ENQ	48	30	0	91	5B	[
6	06	ACK	49	31	1	92	5C	\
7	07	BEL	50	32	2	93	5D]
8	08	BS	51	33	3	94	5E	^
9	09	TAB	52	34	4	95	5F	_
10	0A	LF	53	35	5	96	60	`
11	0B	VT	54	36	6	97	61	a
12	0C	FF	55	37	7	98	62	b
13	0D	CR	56	38	8	99	63	c
14	0E		57	39	9	100	64	d
15	0F		58	3A	:	101	65	e
16	10		59	3B	;	102	66	f
17	11		60	3C	<	103	67	g
18	12		61	3D	=	104	68	h
19	13		62	3E	>	105	69	i
20	14		63	3F	?	106	6A	j
21	15	NAK	64	40	@	107	6B	k
22	16		65	41	A	108	6C	l
23	17		66	42	B	109	6D	m
24	18		67	43	C	110	6E	n
25	19		68	44	D	111	6F	o
26	1A		69	45	E	112	70	p
27	1B	ESC	70	46	F	113	71	q
28	1C		71	47	G	114	72	r
29	1D		72	48	H	115	73	s
30	1E		73	49	I	116	74	t
31	1F		74	4A	J	117	75	u
32	20	SPACE	75	4B	K	118	76	v
33	21	!	76	4C	L	119	77	w
34	22	"	77	4D	M	120	78	x
35	23	#	78	4E	N	121	79	y
36	24	\$	79	4F	O	122	7A	z
37	25	%	80	50	P	123	7B	{
38	26	&	81	51	Q	124	7C	
39	27	'	82	52	R	125	7D	}
40	28	(83	53	S	126	7E	~
41	29)	84	54	T	127	7F	DEL
42	2A	*	85	55	U			

Note: Often used values are gray.



Bonfiglioli Worldwide & BEST Partners

- AUSTRALIA**
BONFIGLIOLI TRANSMISSION (Aust) Pty Ltd.
101, Plumpton Road, Glendenning NSW 2761, Australia
Locked Bag 1000 Plumpton NSW 2761
Tel. (+61) 2 8811 8000 - Fax (+61) 2 9675 6605
www.bonfiglioli.com.au - sales@bonfiglioli.com.au
- AUSTRIA *BEST***
MOLL MOTOR GmbH
Industriestrasse 8 - 2000 Stockerau
Tel. (+43) 2266 63421+DW - Fax (+43) 6342 180
www.mollmotor.at - office@mollmotor.at
- BELGIUM *BEST***
ESCO TRANSMISSION N.V./S.A.
Culliganlaan 3 - 1831 Machelem Diegem
Tel. (+32) 2 7176460 - Fax (+32) 2 7176461
www.esco-transmissions.be - info@esco-transmissions.be
- BRASIL *BEST***
ATI BRASIL
Rua Omlio Monteiro Soares, 260 - Vila Fanny - 81030-000
Tel. (+41) 334 2091 - Fax (+41) 332 8669
www.atibrasil.com.br - vendas@atibrasil.com.br
- CANADA**
BONFIGLIOLI CANADA INC.
2-7941 Janie Street - Concord, ONTARIO L4K 4L6
Tel. (+1) 905 7384466 - Fax (+1) 905 7389833
www.bonfigliolicanada.com - sales@bonfigliolicanada.com
- CHINA**
BONFIGLIOLI DRIVES (SHANGHAI) CO. LTD.
No. 8 Building, 98 Tian Ying Road
Qingpu District, Shanghai, PRC 201712
Tel. +86 21 69225500 - Fax +86 21 69225511
www.bonfiglioli.cn - bds@bonfiglioli.com.cn
- FRANCE**
BONFIGLIOLI TRANSMISSIONS S.A.
14 Rue Eugène Pottier BP 19
Zone Industrielle de Moimont II - 95670 Marly La Ville
Tel. (+33) 1 34474510 - Fax (+33) 1 34688800
www.bonfiglioli.fr - btf@bonfiglioli.fr
- GERMANY**
BONFIGLIOLI DEUTSCHLAND GmbH
Sperberweg 12 - 41468 Neuss
Tel. (+49) 02131 2988-0 - Fax (+49) 02131 2988-100
www.bonfiglioli.de - info@bonfiglioli.de
- GREAT BRITAIN**
BONFIGLIOLI UK Ltd
Industrial Equipment - Unit 3 Colemeadow Road
North Moons Moat - Redditch, Worcestershire B98 9PB
Tel. (+44) 1527 65022 - Fax (+44) 1527 61995
www.bonfiglioli-uk.com - uksales@bonfiglioli-uk.com
- Mobile Equipment
5 Grosvenor Grange - Woolston - Warrington, Cheshire WA1 4SF
Tel. (+44) 1925 852667 - Fax (+44) 1925 852668
www.bonfiglioli-uk.com - salesmobile@bonfiglioli-uk.com
- GREECE *BEST***
B.E.S.T. HELLAS S.A.
O.T. 48A T.O. 230 - C.P. 570 22 Industrial Area - Thessaloniki
Tel. (+30) 2310 796456 - Fax (+30) 2310 795903
www.bonfiglioli.gr - info@bonfiglioli.gr
- HOLLAND *BEST***
ELSTO AANDRIJFTECHNIEK
Loostenweg, 7 - 2215 TL Voorhout
Tel. (+31) 252 219 123 - Fax (+31) 252 231 660
www.elsto.nl - imfo@elsto.nl
- HUNGARY *BEST***
AGISYS AGITATORS & TRANSMISSIONS Ltd
2045 Törökbalint, Tó u.2. Hungary
Tel. +36 23 50 11 50 - Fax +36 23 50 11 59
www.agisys.hu - info@agisys.hu
- INDIA**
BONFIGLIOLI TRANSMISSIONS PVT Ltd.
PLOT AC7-AC11 Sidco Industrial Estate
Thirumudivakkam - Chennai 600 044
Tel. +91(0)44 24781035 / 24781036 / 24781037
Fax +91(0)44 24780091 / 24781904
www.bonfiglioli.co.in - bonfig@vsnl.com
- ITALY**
BONFIGLIOLI ITALIA S.p.A.
Via Sandro Pertini lotto 7b - 20080 Carpiano (Milano)
Tel. (+39) 02 985081 - Fax (+39) 02 985085817
www.bonfiglioli.it - customerservice.italia@bonfiglioli.it
- NEW ZEALAND *BEST***
SAECO BEARINGS TRANSMISSION
36 Hastie Avenue, Mangere
Po Box 22256, Otahuhu - Auckland
Tel. +64 9 634 7540 - Fax +64 9 634 7552
mark@saeco.co.nz
- POLAND *BEST***
POLPACK Sp. z o.o. - Ul. Chrobrego 135/137 - 87100 Torun
Tel. (+48) 56 6559235 - 6559236 - Fax (+48) 56 6559238
www.polpack.com.pl - polpack@polpack.com.pl
- PORTUGAL *BEST***
BT BONFITEC Equipamentos Industriais, Lda.
Largo do Colegio de Ermesinde, 70 - Formiga 4445-382 Ermesinde
Tel. (+351) 229759634/5/6 - Fax (+351) 229752211
www.bonfitec.pt - bonfitec@bonfitec.pt
- RUSSIA *BEST***
FAM
57, Maly prospekt, V.O. - 199048, St. Petersburg
Tel. +7 812 3319333 - Fax +7 812 3271454
www.fam-drive.ru - info@fam-drive.ru
- SPAIN**
TECNOTRANS BONFIGLIOLI S.A.
Pol. Ind. Zona Franca sector C, calle F, nº6 08040 Barcelona
Tel. (+34) 93 4478400 - Fax (+34) 93 3360402
www.tecnotrans.com - tecnotrans@tecnotrans.com
- SOUTH AFRICA**
BONFIGLIOLI POWER TRANSMISSION Pty Ltd.
55 Galaxy Avenue, Linbro Business Park - Sandton
Tel. (+27) 11 608 2030 OR - Fax (+27) 11 608 2631
www.bonfiglioli.co.za - bonfigsales@bonfiglioli.co.za
- SWEDEN**
BONFIGLIOLI SKANDINAVIEN AB
Koppargatan 8 - 234 35 Lomma, Sweden
Tel. (+46) 40418230 - Fax (+46) 40414508
www.bonfiglioli.se - info@bonfiglioli.se
- THAILAND *BEST***
K.P.T MACHINERY (1993) CO.LTD.
259/83 Soi Phiboovues, Sukhumvit 71 Rd. Phrakonong-nur,
Wattana, Bangkok 10110
Tel. 0066.2.3913030/7111998
Fax 0066.2.7112852/3811308/3814905
www.kpt-group.com - sales@kpt-group.com
- USA**
BONFIGLIOLI USA INC
3541 Hargrave Drive Hebron, Kentucky 41048
Tel.: (+1) 859 334 3333 - Fax: (+1) 859 334 8888
www.bonfiglioliusa.com
industrialsales@bonfiglioliusa.com
mobilesales@bonfiglioliusa.com
- VENEZUELA *BEST***
MAICA SOLUCIONES TECNICAS C.A.
Calle 3B - Edif. Comindu - Planta Baja - Local B
La Urbina - Caracas 1070
Tel. (+58) 212 2413570 / 2425268 / 2418263
Fax (+58) 212 2424552 - Tlx 24780 Maica V
maica1@cantv.net
- HEADQUARTERS**
BONFIGLIOLI RIDUTTORI S.p.A.
Via Giovanni XXIII, 7/A
40012 Lippo di Calderara di Reno
Bologna (ITALY)
Tel. (+39) 051 6473111
Fax (+39) 051 6473126
www.bonfiglioli.com
bonfiglioli@bonfiglioli.com
- SPARE PARTS BONFIGLIOLI**
B.R.T.
Via Castagnini, 2-4
Z.I. Bargellino - 40012
Calderara di Reno - Bologna (ITALY)
Tel. (+39) 051 727844
Fax (+39) 051 727066
www.brtbonfiglioliricambi.it
brt@bonfiglioli.com

**ACTIVE and
ACTIVE Cube**



www.bonfiglioli.com

 **BONFIGLIOLI**